

# JOHNSON CLOSETS



[JOHNSONCLOSETS.COM](http://JOHNSONCLOSETS.COM)

# About US

Johnson Closets is founded by Johnson Chen of Johnson Design Homes. As a premier luxury home builder in the greater Seattle area, Mr. Chen is always searching for the finest quality and design for everything in the homes he builds— closets, pantry, and shelves are no exceptions. However, the quality and installation process of even the existing “brand name” closet and cabinet companies have left much room for improvement.

Mr. Chen's frustration with what was available in the market led to his invention of Johnson Connector. Mr. Chen established a manufacturing factory to make custom closets for his homes with his revolutionary approach to production efficiency. The results are better design and better quality at a lower cost. Seeing the demand for closet solutions, Mr. Chen decided to start Johnson Closets to allow home owners to enjoy enhanced quality products at an affordable price.

# JOHNSON CLOSETS





## Our Differences

### Finest Materials. Best Innovative Hinge System. Most Competitive Price.

Johnson Closets uses only the finest materials. Our closets are made of a combination of solid hardwoods and veneers over 7-ply cabinet plywood cores, as opposed to particle boards used by other popular closet makers. Our fully recyclable products are the ideal choice for green-conscious customers. In addition, the system can be trimmed with solid hardwood crown moulding and base to match the level of trim in your home to complete the custom built-in look.

Johnson Closets uses the most innovative hinge system—our proprietary “Johnson Connector Composite Structure,” patent-pending in the United States, and patented in China and Taiwan. Johnson Connector not only gives us the exclusive benefit of easy installation without exposed nail holes, but also great design efficiency as well as high level of production flexibility and efficiency. The turnaround time from design to a beautifully installed closet system, regardless of the complexity, is only a few days.

Johnson Closets saves you money. We are able to offer higher quality products at a much lower price because:

- (1) We own our manufacturing factory.
- (2) We offer direct sales without the overhead of a middle man.
- (3) We take in a significantly lower profit margin compared to our competitors.



## PANTRY

Whether your pantry is a single wall cabinet or an entire room, you will love how well things are organized and how easy it is to find the things you need.

## BOOKCASES

In your home office or family room, our bookshelves not only add functional space for organizing your collection of books or photo albums, but add elegance to a traditional or contemporary style room as well.

## WALK-IN CLOSETS

Walk-in closets should be the most functional space in your home. They should also reflect your personality and your style.

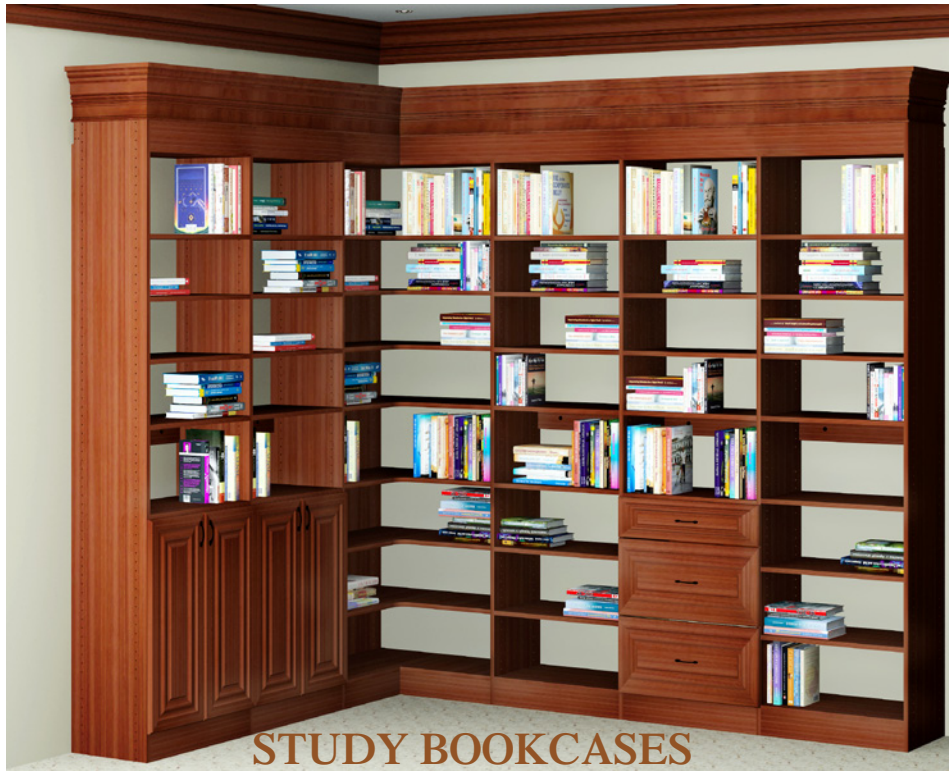

STUDY BOOKCASES



WINE RACK



## DESIGN

There are many factors to consider when designing a storage solution. What are you storing? What is your budget? Once you have decided on your need and priority, you are ready to begin.

## MEASURE THE SPACE

Taking measurements of your space is an important step in the design process. You will need accurate measurements of your room, including doorways, windows, and other openings to cut for a perfect fit.

- (1) For walk-in closets and pantries: take measurement of the surrounding walls of the room.
- (2) For reach-in spaces: take measurement of the back wall and the two return walls of your closet/pantry. Since most walls are not perfectly squared, we recommend that you measure across each wall at 3 different heights and record the smallest dimension.

Once you have all the measurements, sketch an overhead view of the room and add the wall dimensions and any openings.

# OUR PATENT

Our patented “Johnson Connector Composite Structure” makes installation easy and precise, all without exposed nail holes. The traditional “screws and nails” approach used by other closet companies requires the skills of fine carpentry, while the innovative locking mechanism of Johnson Connector makes precision and tight fit achievable, even for home owners.

“Johnson Connector Composite Structure” is currently patented in China and Taiwan, and patent-pending in the United States.

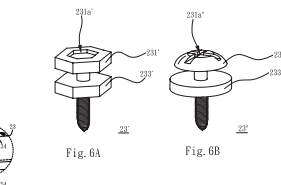
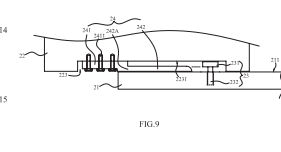
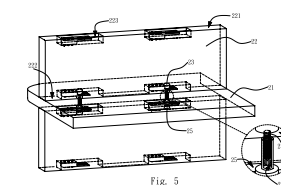
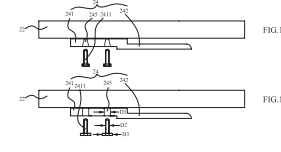
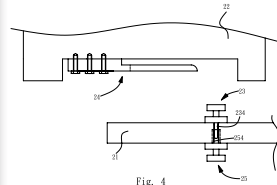
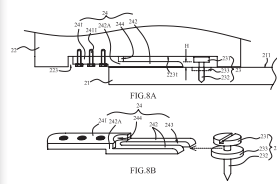
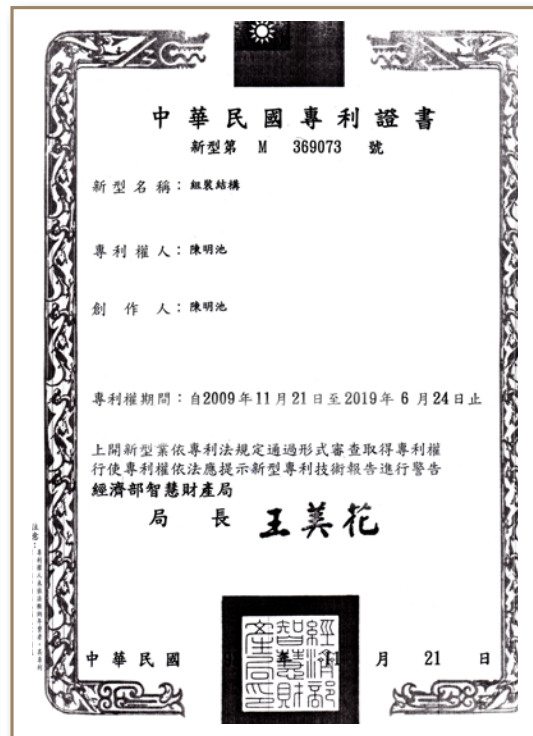
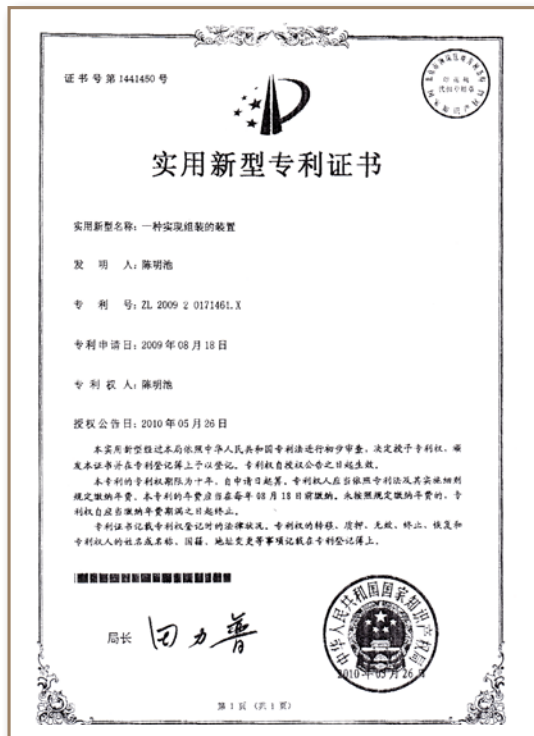

# MODEL: HG-90" (CUT) MODEL: HG-47" (CUT)

## COLORS



Cherry Honey

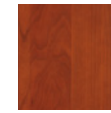

Cherry Medium



Cherry Dark

## INSTALLATION: PAGE 1

- 1 Install top of wall track, level, entire length of wall 89 1/2 inches above the floor. Secure wall track to studs 16 inches on center with 2 inch screws. To splice wall track – overlap and install two 2 inch screws into sheet rock. (No stud required.)

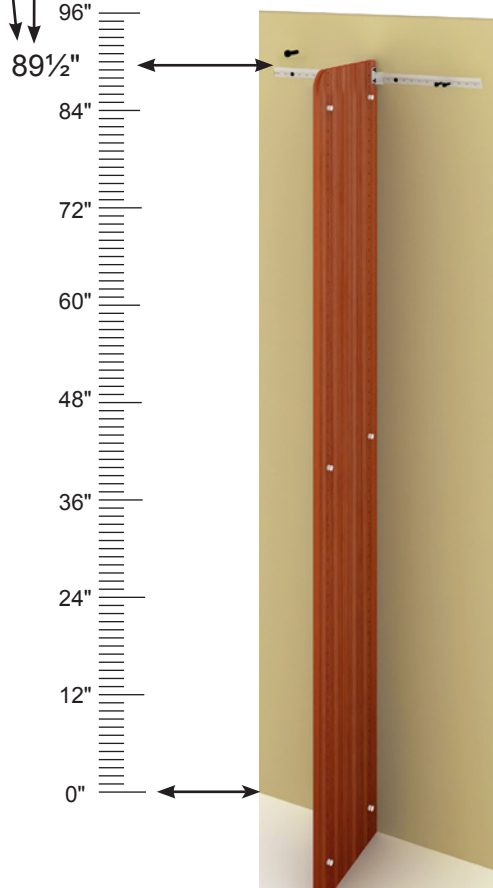
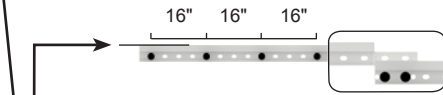

### MODEL: HG-47" (CUT)

#### Cut to Fit



- 3 Cut one end of shelving to desired length



- 2 Install mounting bracket to side/end panel with bolt and wing nut supplied. (Hand tight) Then hang panel to top of wall track.

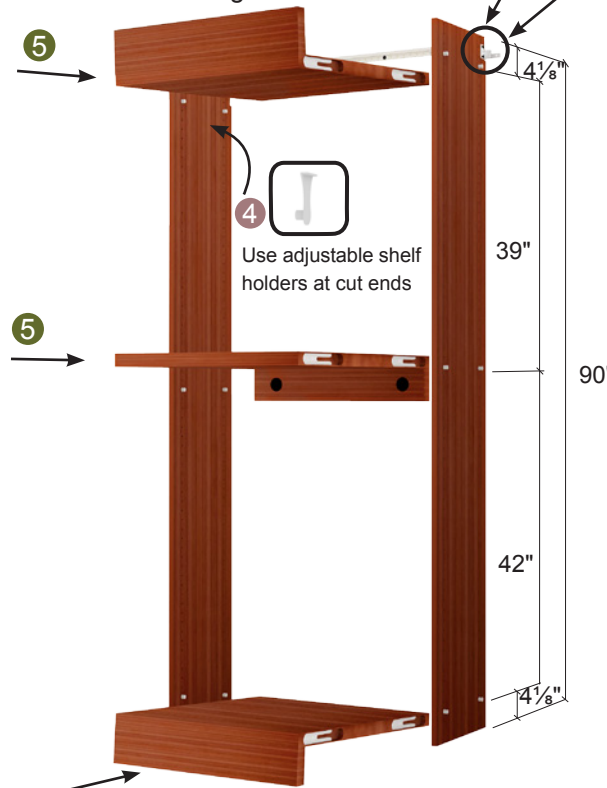

- 5 Install support shelf, starting from bottom to top use shelf holders in end panel at cut ends.

### MODEL: HG-47" (CUT)

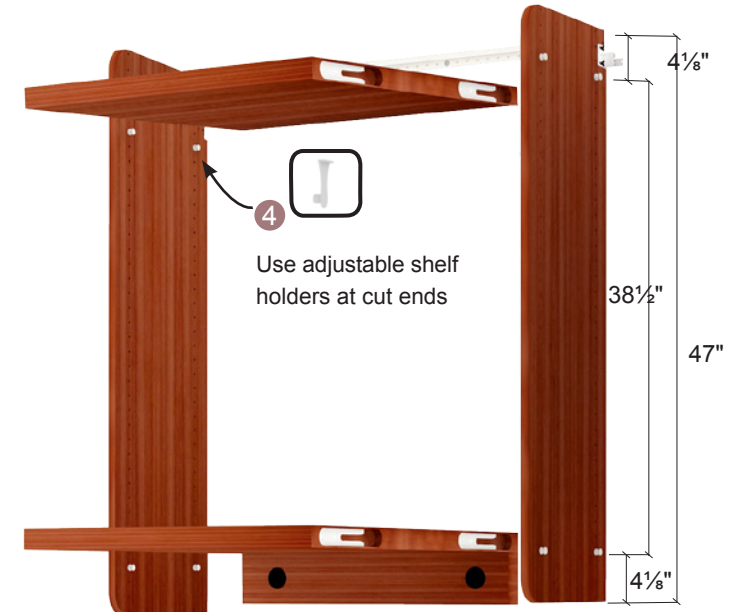

## FACES & FINISHES

We offer many different styles of door and drawer faces for a traditional or contemporary theme, and a range of diverse finishes to match the trim level of your home and decorating needs.

## Door Style (Colors)



A1-a



A1-b

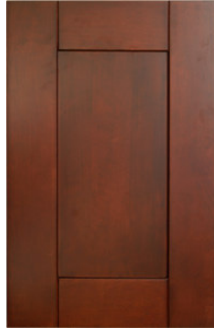

A1-c



A1-d



CH1-a



CH1-b

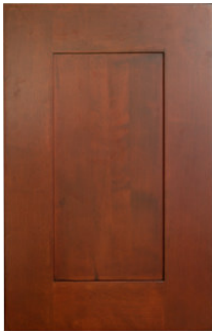

CH1-c



CH1-d



A3-b



A3-c



A3-d



B1



A4-a



A4-b



A4-c



A4-d





FACES & FINISHES

We offer many different styles of door and drawer faces for a traditional or contemporary theme, and a range of diverse finishes to match the trim level of your home and decorating needs.

Cherry Door Style (Colors)



CM-45 Cherry Medium



CD-45 Cherry Dark



CB-90 Cherry Brown



G-CB-90  
Cherry Brown



G-CM-45  
Cherry Medium



C-45 Drawers Style



Cherry Honey

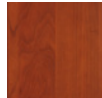

Cherry Medium

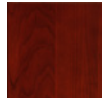

Cherry Dark

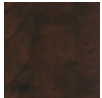

Cherry Brown

Maple Door Style (Colors)



MH-90 Maple Honey



MM-90 Maple Medium



MB-90 Maple Brown



G-MH-90  
Maple Honey



M-90 Drawers Style



Maple Honey

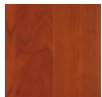

Maple Medium

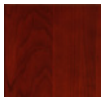

Maple Dark

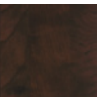

Maple Brown

# CONTENTS



DOUBLE HANG  
SC-303290 ..... 01-02



LONG HANG  
SCL-303290 ... 03-04



DOUBLE HANG  
SC-303247 ..... 05-06



LONG HANG  
SCL-303247 .... 07-08



T-SHELF-DOUBLE &  
SINGLE HANG  
HG-47" ..... 09-10



LONG HANG  
HGL-47" ..... 11-12



DOUBLE HANG  
HG-90" .... 13-14



GARAGE  
STORAGE  
GC-90" ... 15-16



LONG HANG  
HGL-90" ... 17-18



HAMPER  
HP-90" .... 19-22



BASKET  
BS-90" .... 23-26



DRAWERS-DOOR  
DD-90" .... 27-32



SHOE  
SH-90" ..... 33-36



HUTCHES  
HU-3090 ..... 37-38



T-HANG DRAWERS  
HD-71" ..... 39-41

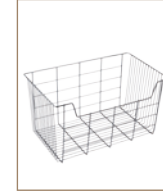

HARDWARE  
ACCESSORY  
(CLOSETS)



HARDWARE  
ACCESSORY  
(CLOSETS) .... 42

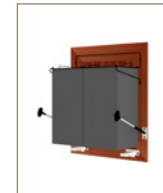

HARDWARE  
ACCESSORY  
(CLOSETS)



**LIGHT  
BAFFLE  
MOULDING** ----- 42



**LIST OF  
PRODUCTS** ----- 43-46



**BASE  
CABINETS** ----- 47-48



**VANITY  
BASE  
CABINETS** ----- 49



**WALL  
CABINETS** ----- 50-52



**SET  
CABINETS** ----- 53-54



**STUDY  
BOOK-  
CASES** ----- 22

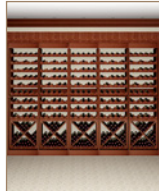

**WINE  
RACK** ----- 32

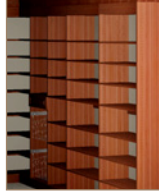

**KITCHEN  
PANTRY** ----- 55

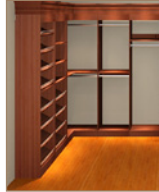

**WALK-  
IN CLOSET** ----- 56



**REACH-IN  
CLOSET** ----- 57



**GC-3090  
GARAGE  
STORAGE** ----- 58



-----



-----



-----



-----



-----



-----





## INSTALLATION: PAGE 1 of 2

- 1** Install top of wall track, level, entire length of wall 89 ½ inches above the floor. Secure wall track to studs 16 inches on center with 2 inch screws. To splice wall track – overlap and install two 2 inch screws into sheet rock. (No stud required.)

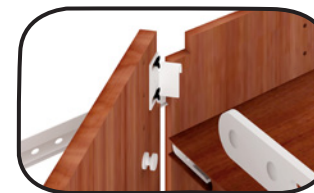
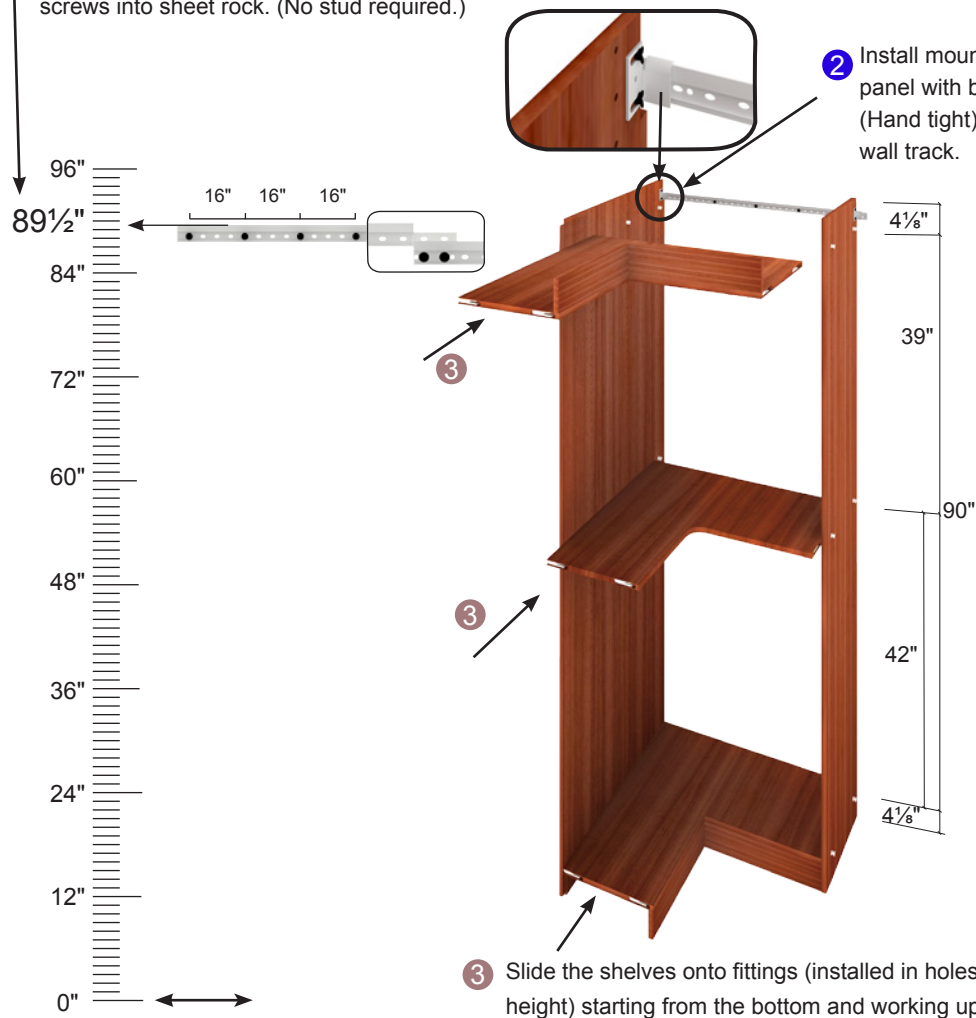

- 5** Install mounting bracket to wall track and attach to second end panel with bolt and wing nut supplied. (Hand tight)

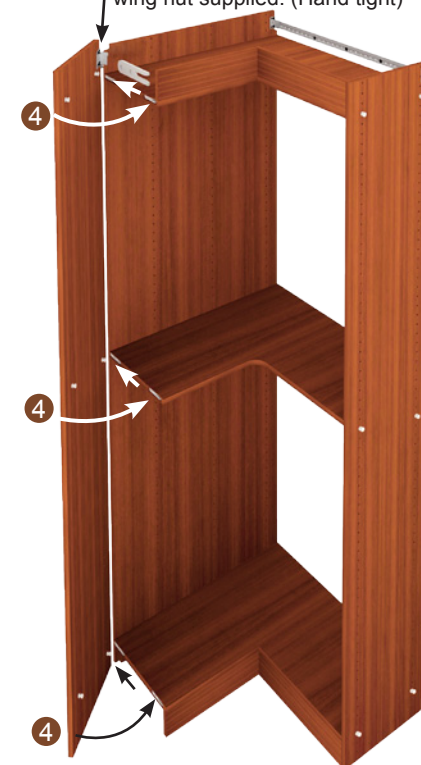

Install fittings in corresponding holes in second end panel and slide end panel onto end of shelves. (Wait to install mounting bracket after end panel is in place.) See step #5.

# MODEL: SC-303290 (1-3) DOUBLE HANG

## COLORS



Cherry Honey

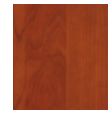

Cherry Medium



Cherry Dark

## INSTALLATION: PAGE 2 of 2

### SC-303290 (1)

Size inch		Amount	Colors
30"	32"		

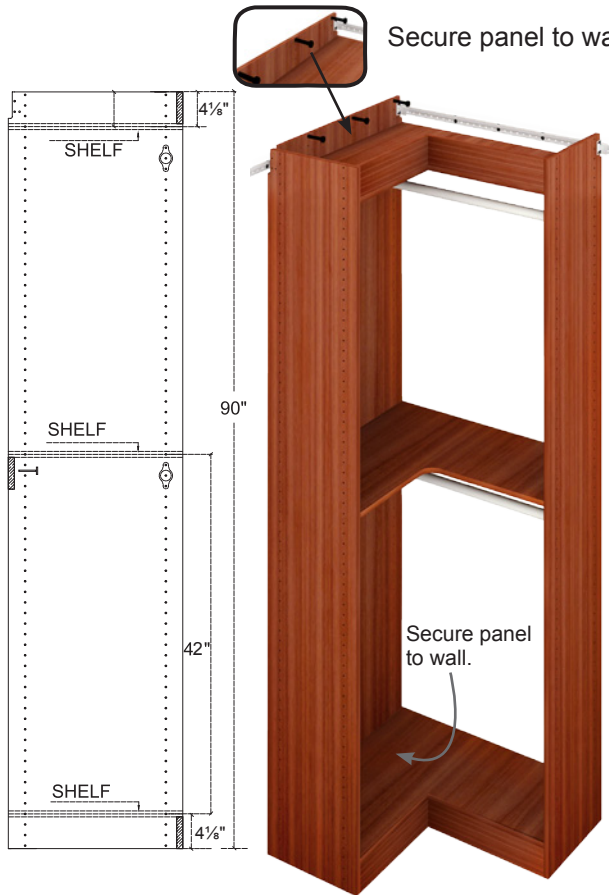

### SC-303290 (2)

Size inch		Amount	Colors
30"	32"		

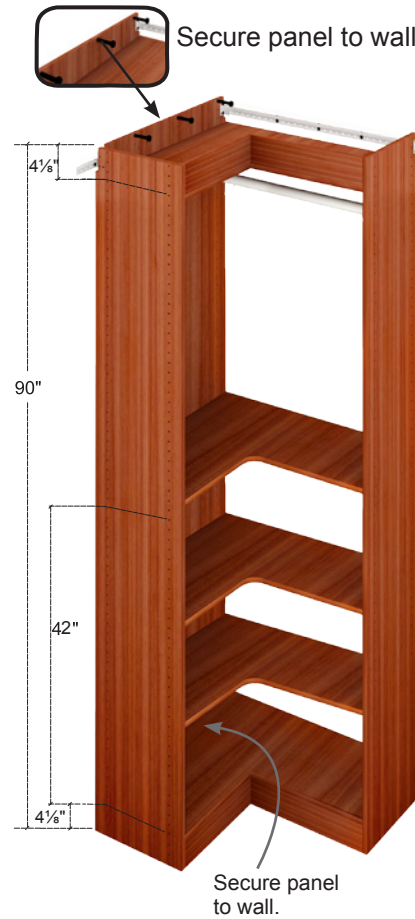

### SC-303290(3)

Size inch		Amount	Colors
30"	32"		

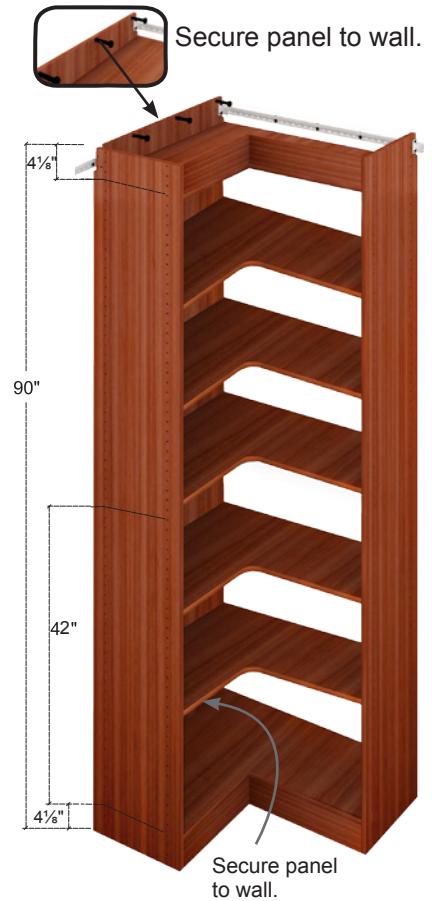

### INSTALLATION: PAGE 1 of 2

- 1** Install top of wall track, level, entire length of wall 89 ½ inches above the floor. Secure wall track to studs 16 inches on center with 2 inch screws. To splice wall track – overlap and install two 2 inch screws into sheet rock. (No stud required.)

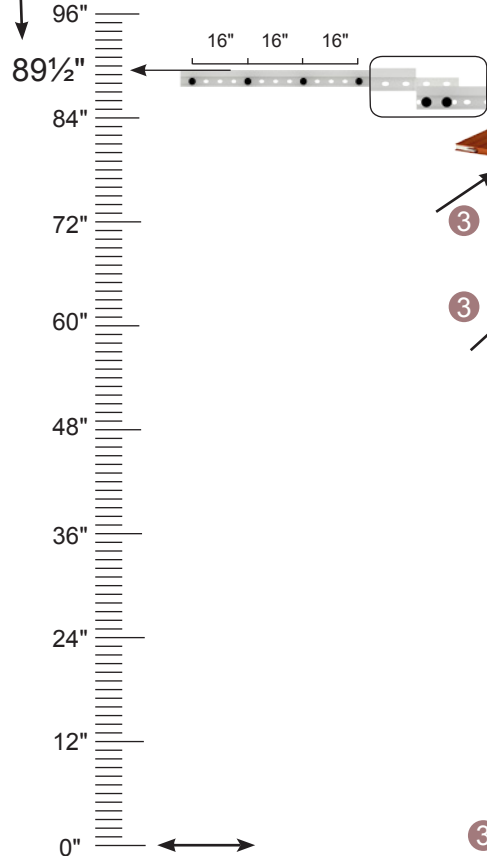

- 2** Install mounting bracket to side/end panel with bolt and wing nut supplied. (Hand tight) Then hang panel to top of wall track.



- 3** Slide the shelves onto fittings (installed in holes at designated height) starting from the bottom and working up.

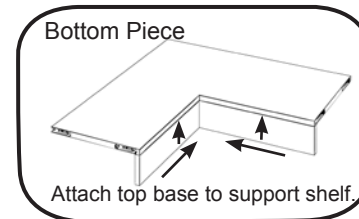
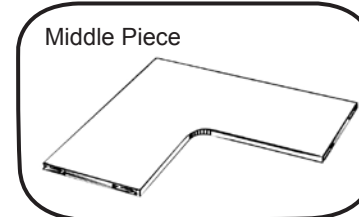
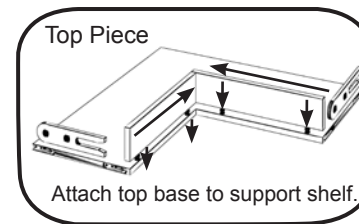

- 5** Install mounting bracket to wall track and attach to second end panel with bolt and wing nut supplied. (Hand tight)

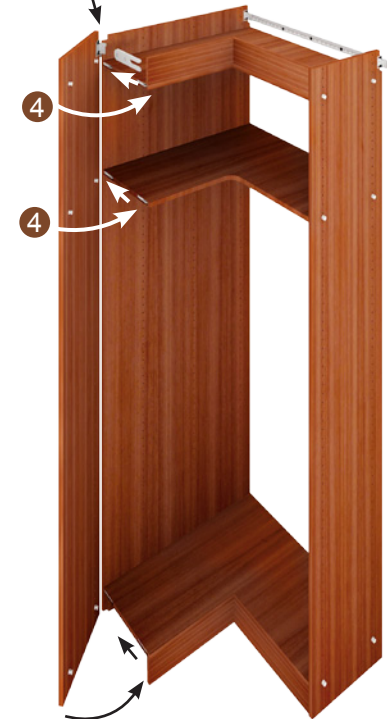

- 4** Install fittings in corresponding holes in second end panel and slide end panel onto end of shelves. (Wait to install mounting bracket after end panel is in place.) See step #5.



# MODEL: SCL-303290 (1-3) LONG HANG

COLORS



Cherry Honey

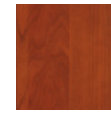

Cherry Medium



Cherry Dark

## INSTALLATION: PAGE 2 of 2

### SCL-303290 (1)

Size inch			Amount	Colors
30"	32"			

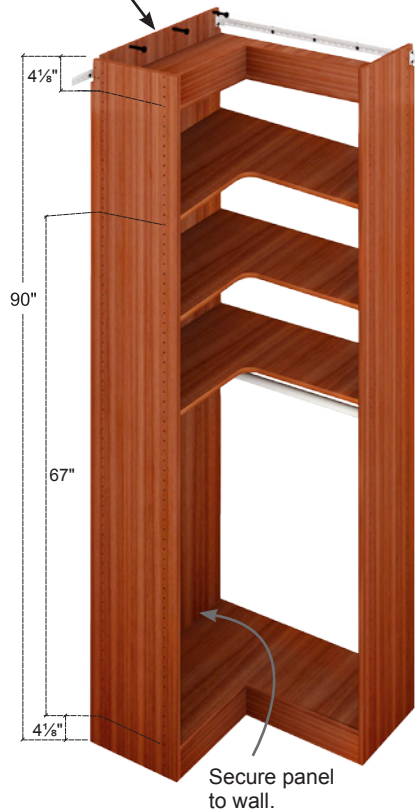
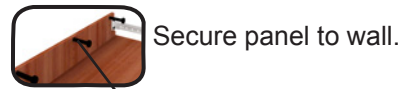

### SCL-303290 (2)

Size inch			Amount	Colors
30"	32"			

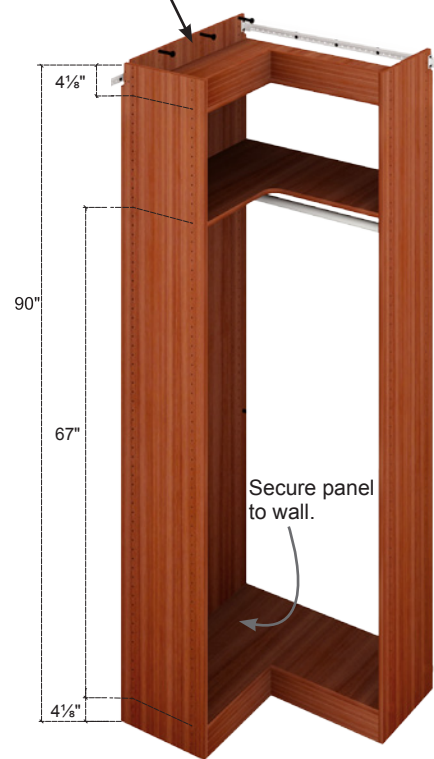
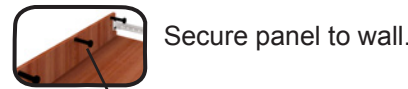

### SCL-303290 (3)

Size inch			Amount	Colors
30"	32"			

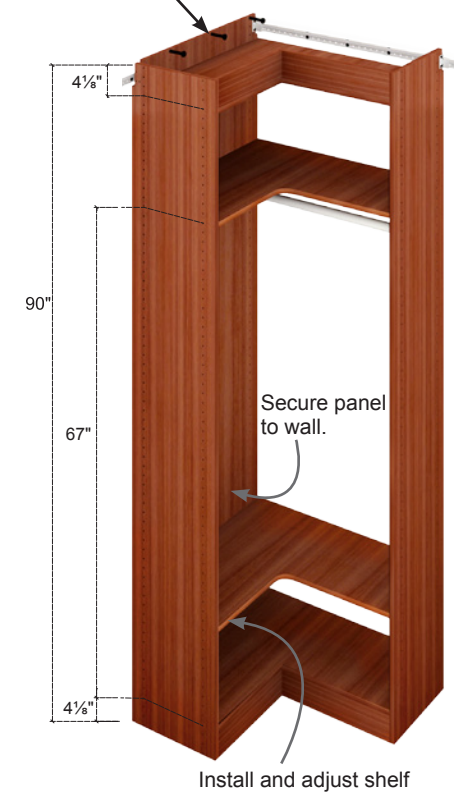
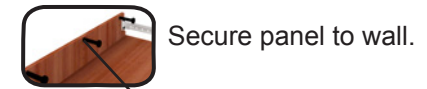

**INSTALLATION: PAGE 1 of 2**

- 1** Install top of wall track, level, entire length of wall 86 inches above the floor. Secure wall track to studs 16 inches on center with 2 inch screws. To splice wall track – overlap and install two 2 inch screws into sheet rock. (No stud required.)

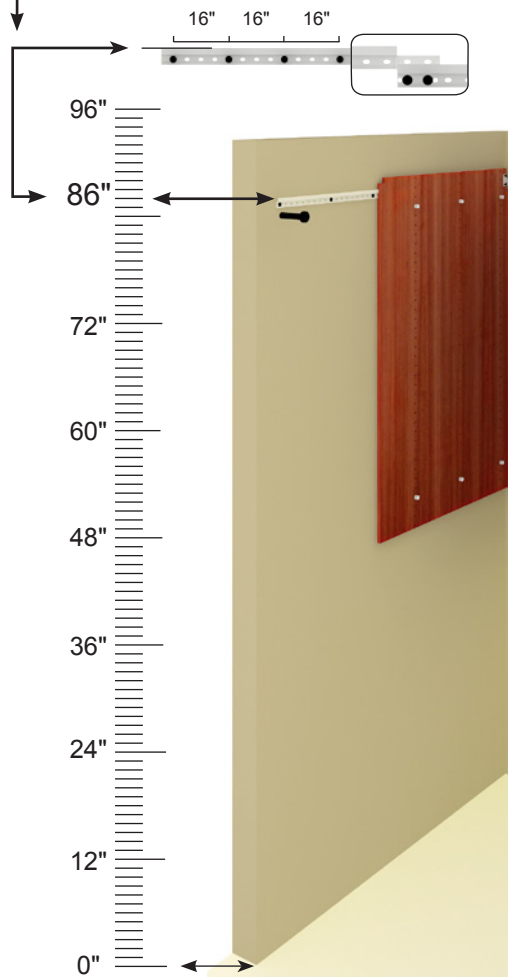

- 2** Install mounting bracket to side/end panel with bolt and wing nut supplied. (Hand tight) Then hang panel to top of wall track.

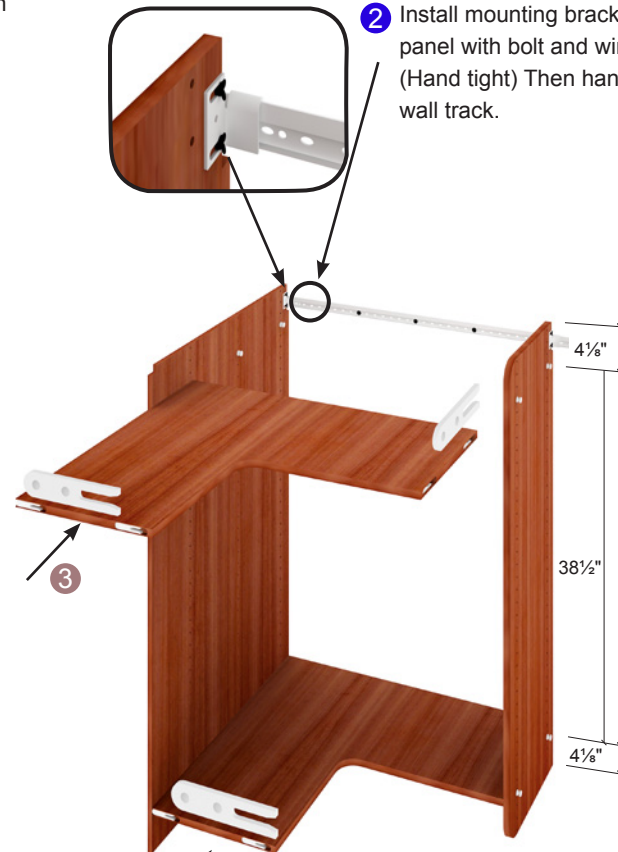

- 3** Slide the shelves onto fittings (installed in holes at designated height) starting from the bottom and working up.

- 5** Install mounting bracket to wall track and attach to second end panel with bolt and wing nut supplied. (Hand tight)



- 4** Install fittings in corresponding holes in second end panel and slide end panel onto end of shelves. (Wait to install mounting bracket after end panel is in place.) See step #5.

# MODEL: SC-303247(1-2) DOUBLE HANG

## COLORS



Cherry Honey

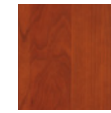

Cherry Medium



Cherry Dark

## INSTALLATION: PAGE 2 of 2

### SC-303247 (1)

Size inch			Amount	Colors
30"	32"			

Secure panel to wall.

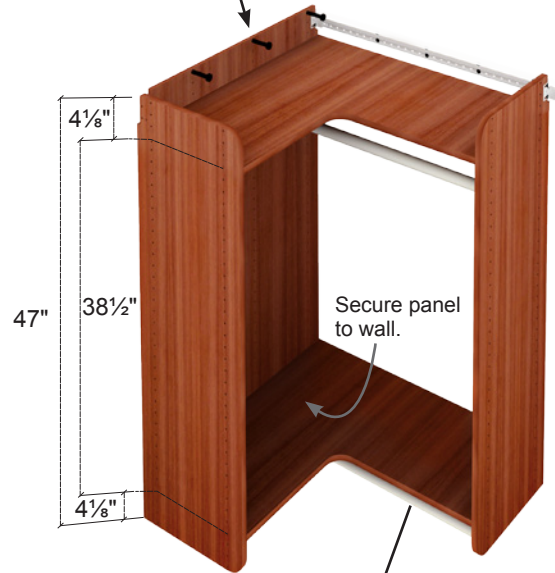
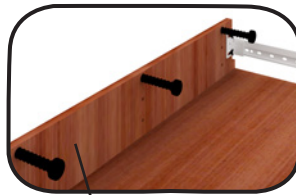

Slide clothes rod brackets onto clothes rod. Secure to side panel.

### SC-303247 (2)

Size inch			Amount	Colors
30"	32"			

Secure panel to wall.



Slide clothes rod brackets onto clothes rod. Secure to side panel.

**INSTALLATION: PAGE 1 of 2**

- 1** Install top of wall track, level, entire length of wall 86 inches above the floor. Secure wall track to studs 16 inches on center with 2 inch screws. To splice wall track – overlap and install two 2 inch screws into sheet rock. (No stud required.)

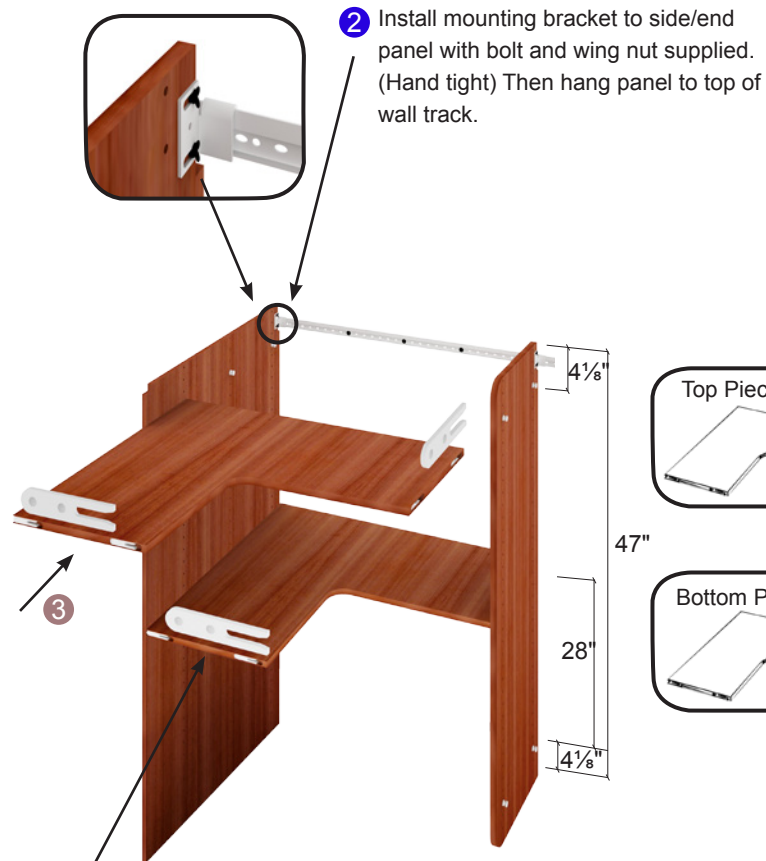
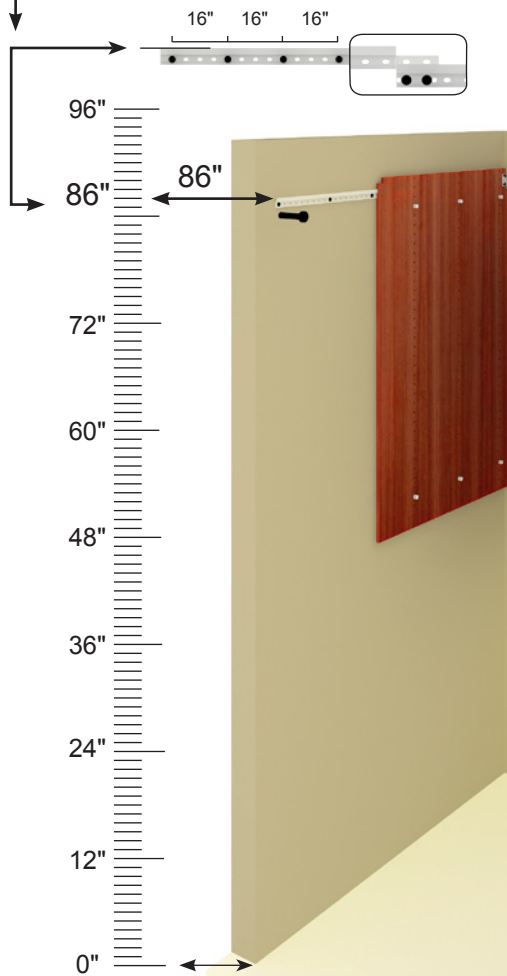

- 2** Install mounting bracket to side/end panel with bolt and wing nut supplied. (Hand tight) Then hang panel to top of wall track.

- 3** Slide the shelves onto fittings (installed in holes at designated height) starting from the bottom and working up.

- 5** Install mounting bracket to wall track and attach to second end panel with bolt and wing nut supplied. (Hand tight)



- 4** Install fittings in corresponding holes in second end panel and slide end panel onto end of shelves. (Wait to install mounting bracket after end panel is in place.) See step #5.

# MODEL: SCL-303247 (1-2) LONG HANG

## COLORS



Cherry Honey

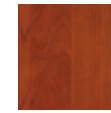

Cherry Medium



Cherry Dark

## INSTALLATION: PAGE 2 of 2

### SCL-303247 (1)

Size inch			Amount	Colors
30"	32"			

Secure panel to wall.



Slide clothes rod brackets onto clothes rod. Secure to side panel.

### SCL-303247 (2)

Size inch			Amount	Colors
30"	32"			

Secure panel to wall.

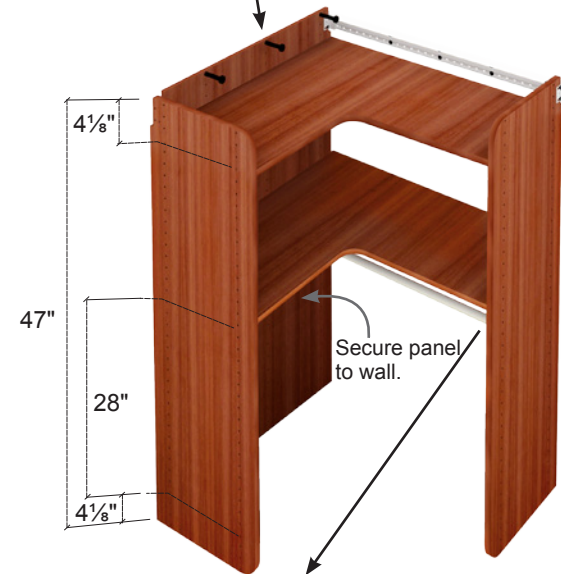

Slide clothes rod brackets onto clothes rod. Secure to side panel.

### INSTALLATION: PAGE 1 of 2

- 1** Install top of wall track, level, entire length of wall 86 inches above the floor. Secure wall track to studs 16 inches on center with 2 inch screws. To splice wall track – overlap and install two 2 inch screws into sheet rock. (No stud required.)

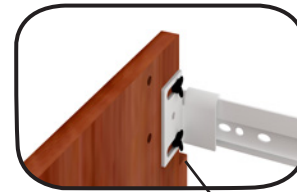
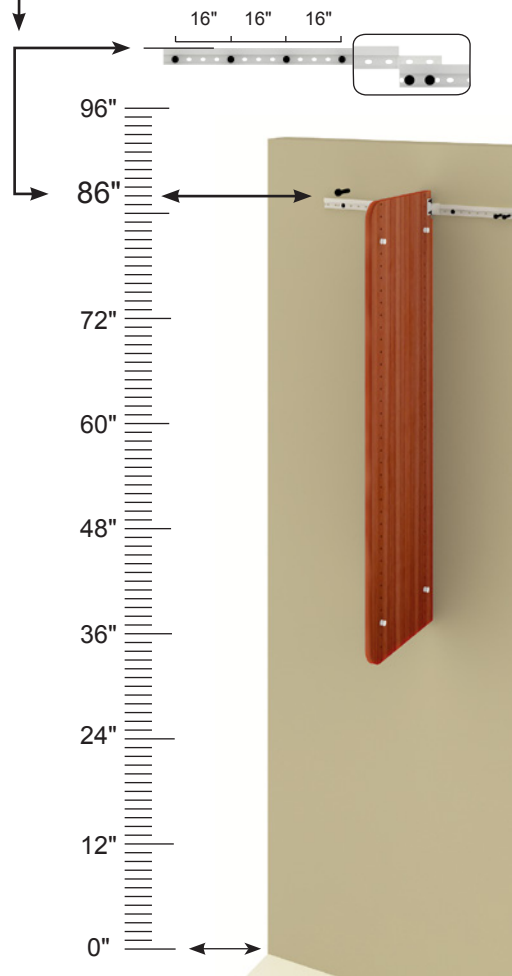

- 2** Install mounting bracket to side/end panel with bolt and wing nut supplied. (Hand tight) Then hang panel to top of wall track.



- 3** Slide the shelves onto fittings (installed in holes at designated height) starting from the bottom and working up.

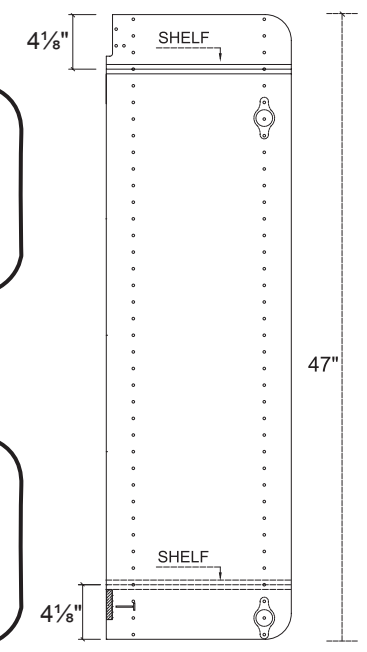
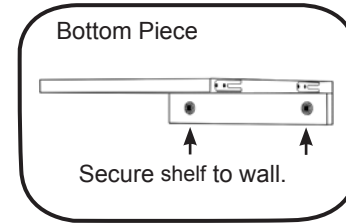
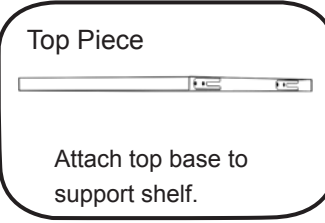

# MODEL: HG-47" (1-2) DOUBLE HANG

## COLORS



Cherry Honey

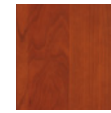

Cherry Medium



Cherry Dark

## INSTALLATION: PAGE 2 of 2

### HG-47" (1)

Size inch			Amount	Colors
24"	30"	36"		

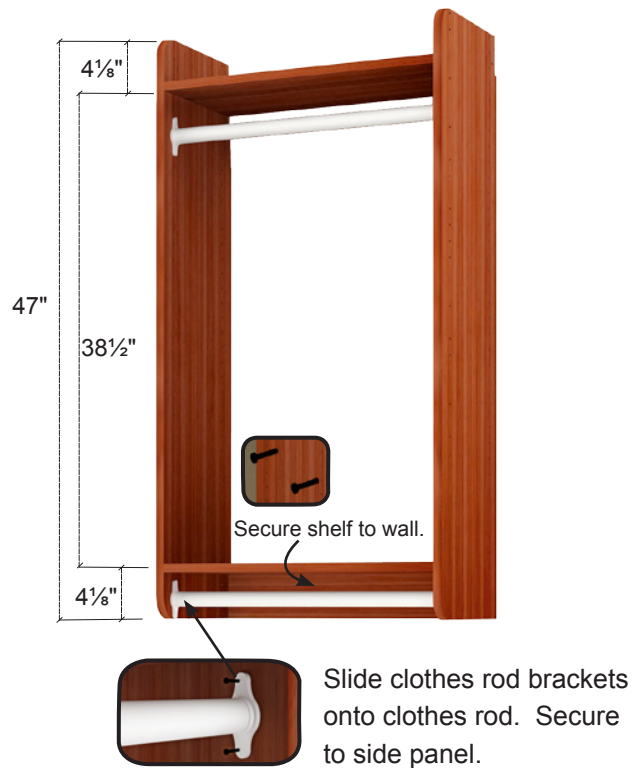

### HG-47" (2)

Size inch			Amount	Colors
24"	30"	36"		



## INSTALLATION: PAGE 1 of 2

- 1 Install top of wall track, level, entire length of wall 86 inches above the floor. Secure wall track to studs 16 inches on center with 2 inch screws. To splice wall track – overlap and install two 2 inch screws into sheet rock. (No stud required.)

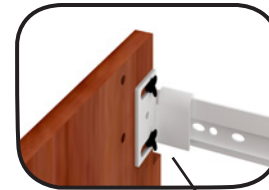
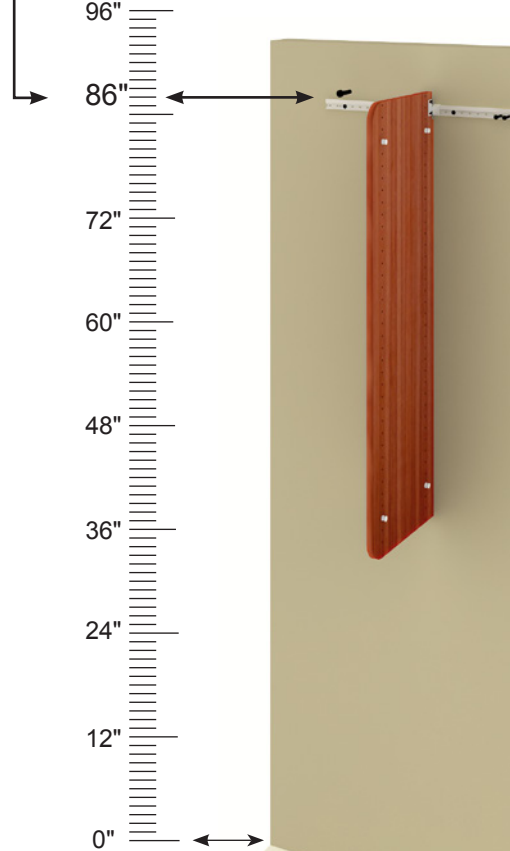
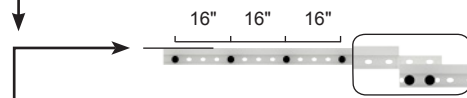

- 2 Install mounting bracket to side/end panel with bolt and wing nut supplied. (Hand tight) Then hang panel to top of wall track.



- 3 Slide the shelves onto fittings (installed in holes at designated height) starting from the bottom and working up.

Top Piece

Attach top base to support shelf.

Bottom Piece

Secure shelf to wall.

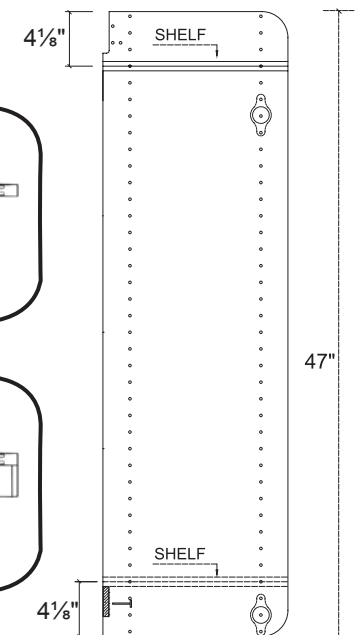



# MODEL: HGL-47" (1-2) LONG HANG

## COLORS



Cherry Honey

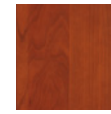

Cherry Medium



Cherry Dark

## INSTALLATION: PAGE 2 of 2

### HGL-47" (1)

Size inch				Amount	Colors
24"	30"	36"			

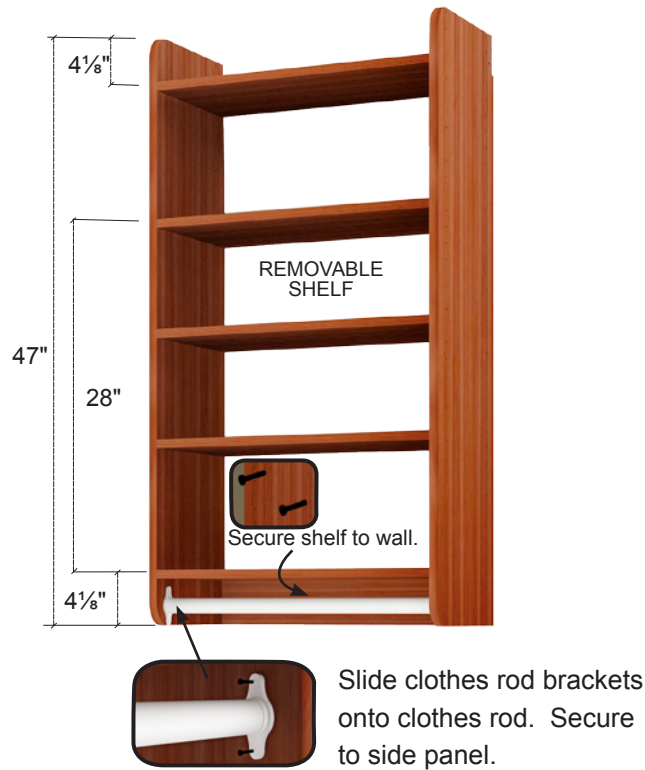

### HGL-47" (2)

Size inch				Amount	Colors
24"	30"	36"			



# MODEL: HG-90" (4 OPTIONS) DOUBLE HANG

HG-90" (1)  
HG-90" (3)

HG-90" (2)  
HGS-90" (4)

## INSTALLATION: PAGE 1 of 2

- 1 Install top of wall track, level, entire length of wall 89 ½ inches above the floor. Secure wall track to studs 16 inches on center with 2 inch screws. To splice wall track – overlap and install two 2 inch screws into sheet rock. (No stud required.)

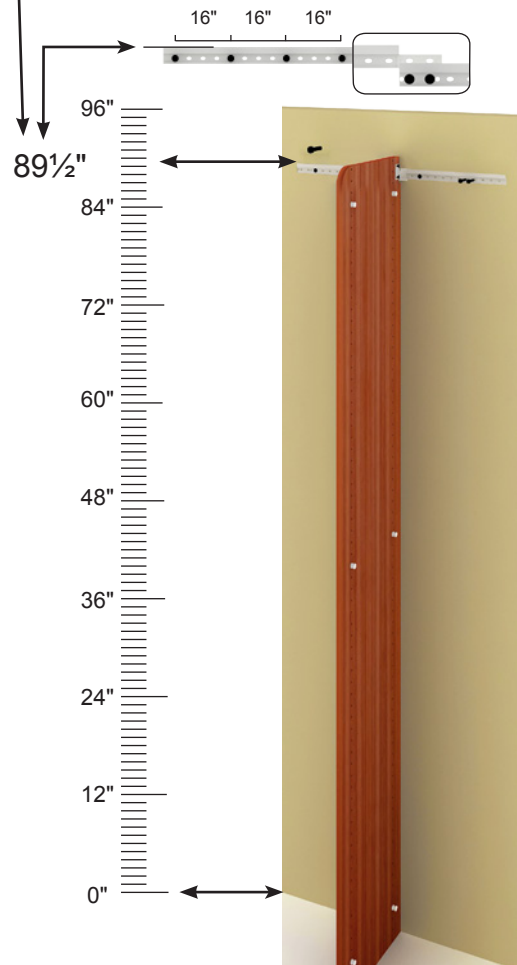

- 2 Install mounting bracket to side/end panel with bolt and wing nut supplied. (Hand tight) Then hang panel to top of wall track.

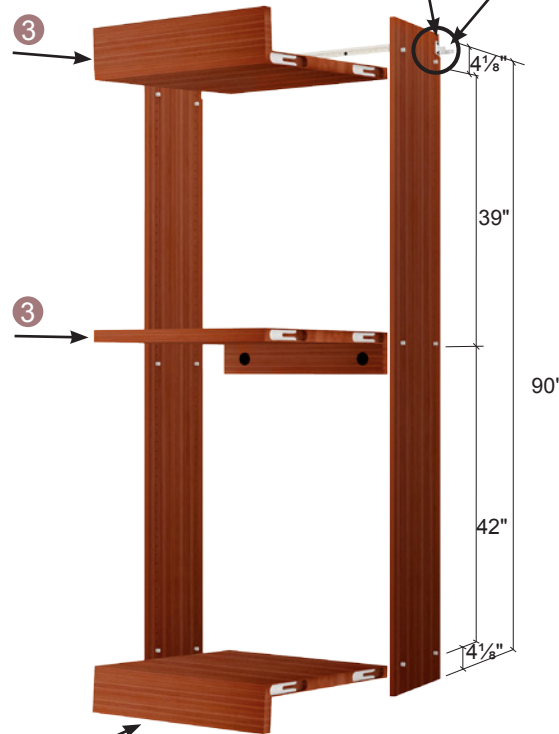

- 3 Slide the shelves onto fittings (installed in holes at designated height) starting from the bottom and working up.

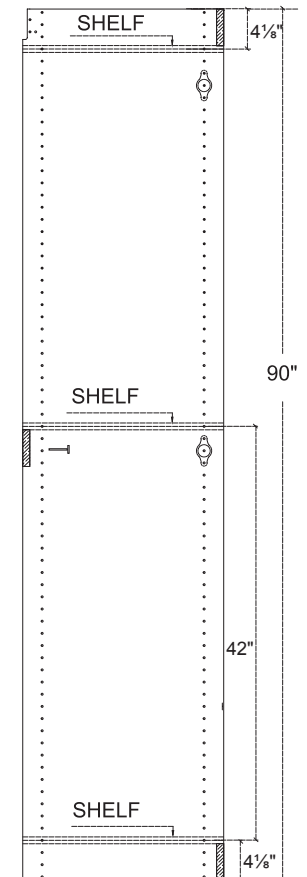
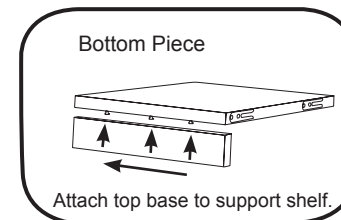
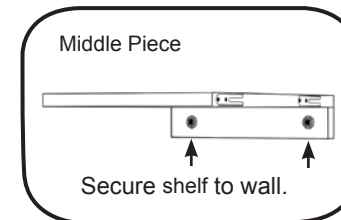
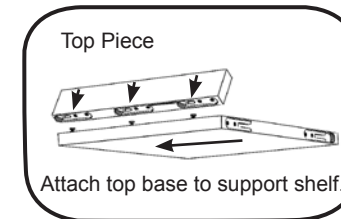

# MODEL: HG-90" (1-4) DOUBLE HANG

## COLORS



Cherry Honey

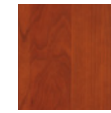

Cherry Medium



Cherry Dark

## INSTALLATION: PAGE 2 of 2

### HG-90" (1)

Size inch			Amount	Colors
24"	30"	36"		

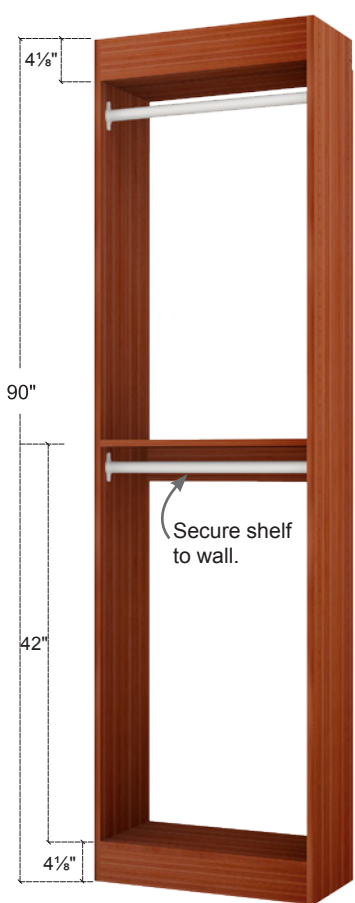

### HG-90" (2)

Size inch			Amount	Colors
24"	30"	36"		

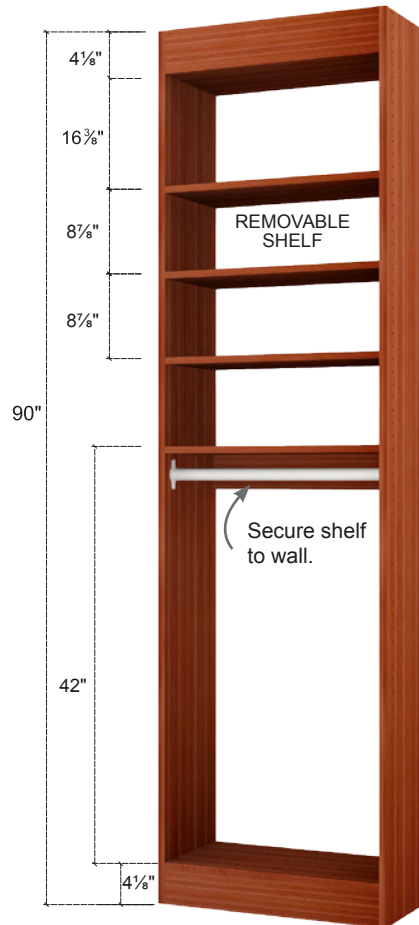

### HG-90" (3)

Size inch			Amount	Colors
24"	30"	36"		

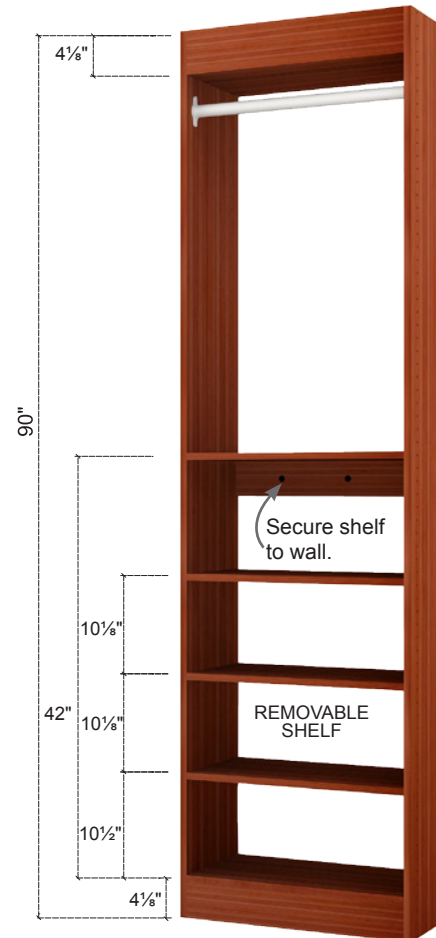

### HGS-90" (4)

Size inch			Amount	Colors
24"	30"	36"		

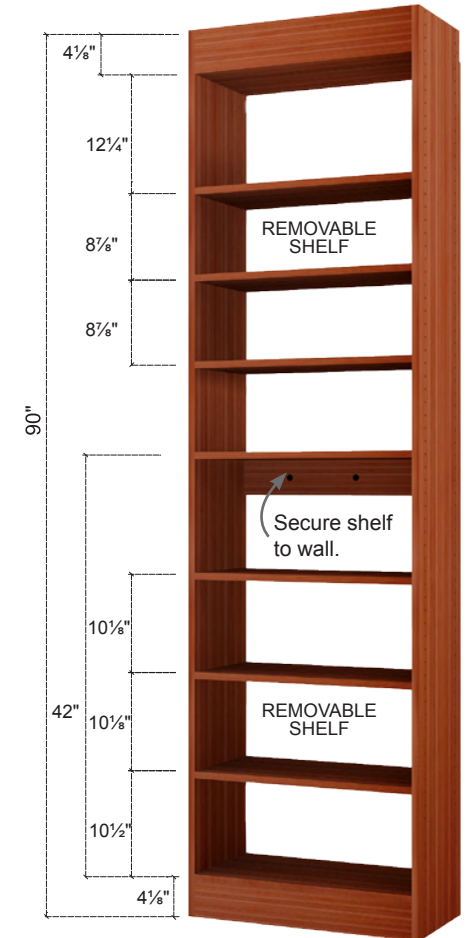

# MODEL: GC-90" (4 OPTIONS)

## GARAGE STORAGE DOUBLE DOOR

GC309018 (1)  
GS309018 (3)

GC309018 (2)  
WINE RACK-2490 (4)

### INSTALLATION: PAGE 1 of 2

- 1** Install top of wall track, level, entire length of wall 89 ½ inches above the floor. Secure wall track to studs 16 inches on center with 2 inch screws. To splice wall track – overlap and install two 2 inch screws into sheet rock. (No stud required.)

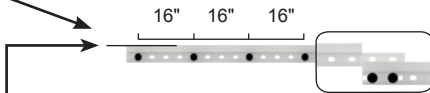

- 2** Install mounting bracket to side/end panel with bolt and wing nut supplied. (Hand tight) Then hang panel to top of wall track.

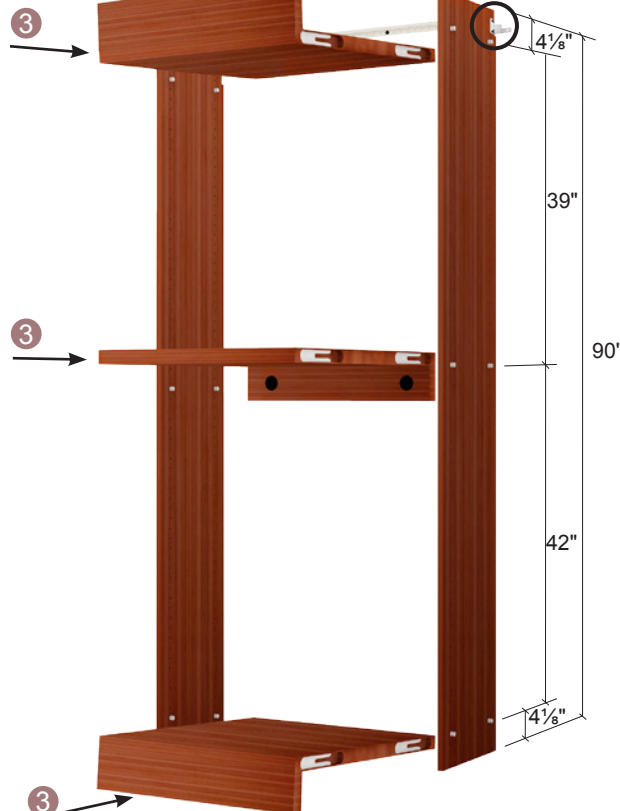
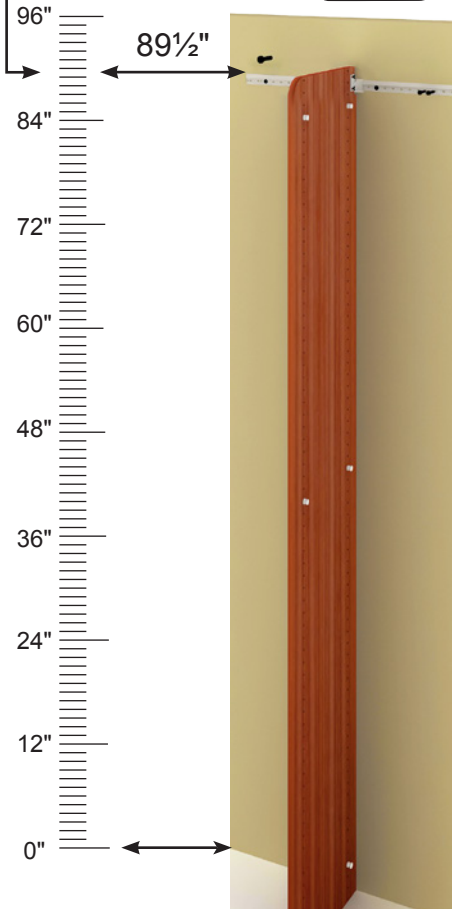

- 3** Slide the shelves onto fittings (installed in holes at designated height) starting from the bottom and working up.

Top Piece

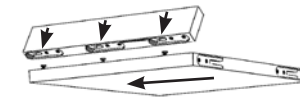

Attach top base to support shelf.

Middle Piece

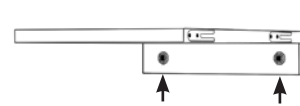

Secure shelf to wall.

Bottom Piece

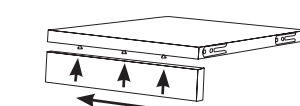

Attach top base to support shelf

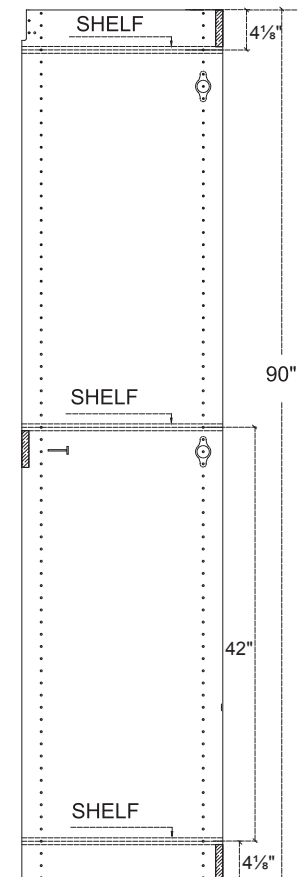

**MODEL: GC-90" (1-4)**  
**GARAGE STORAGE DOUBLE DOOR**

**COLORS**



Cherry Honey

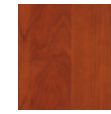

Cherry Medium



Cherry Dark

**INSTALLATION: PAGE 2 of 2**

**GC309018 (1)**

Size inch			Amount	Colors
30"				



**GC309018 (2)**

Size inch			Amount	Colors
30"				

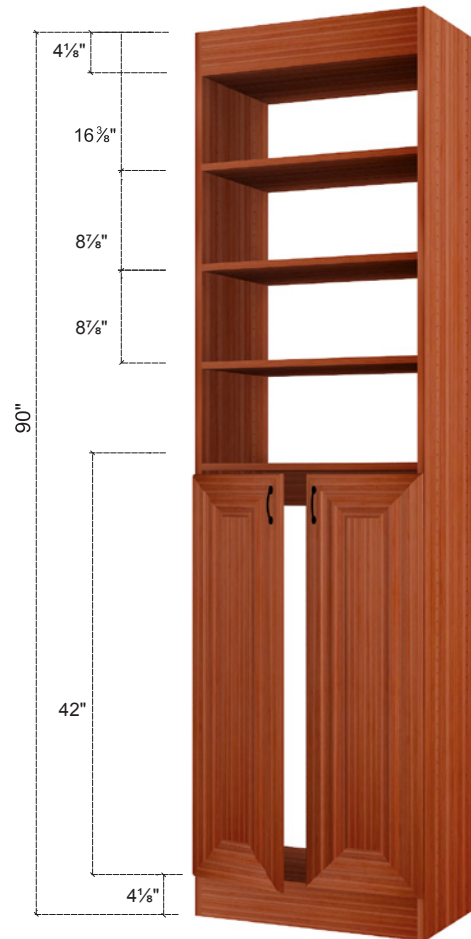

**GS309018 (3)**

Size inch			Amount	Colors
30"				

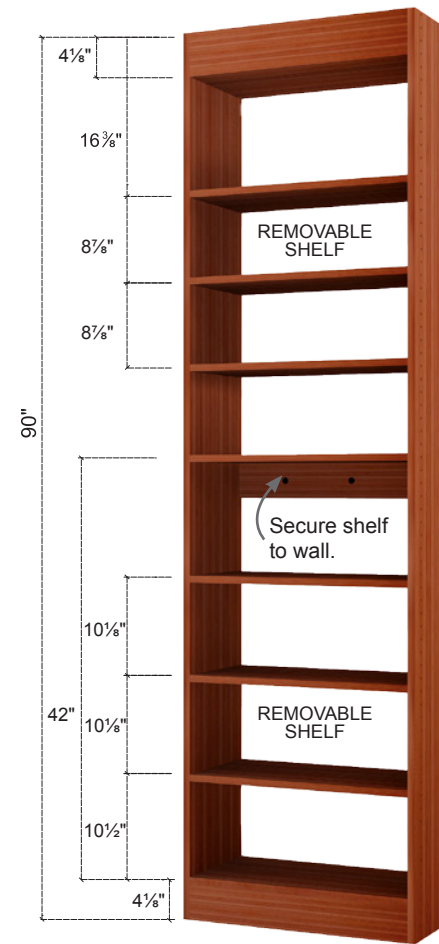

**WINE RACK-2490 (4)**

Size inch			Amount	Colors
24"				

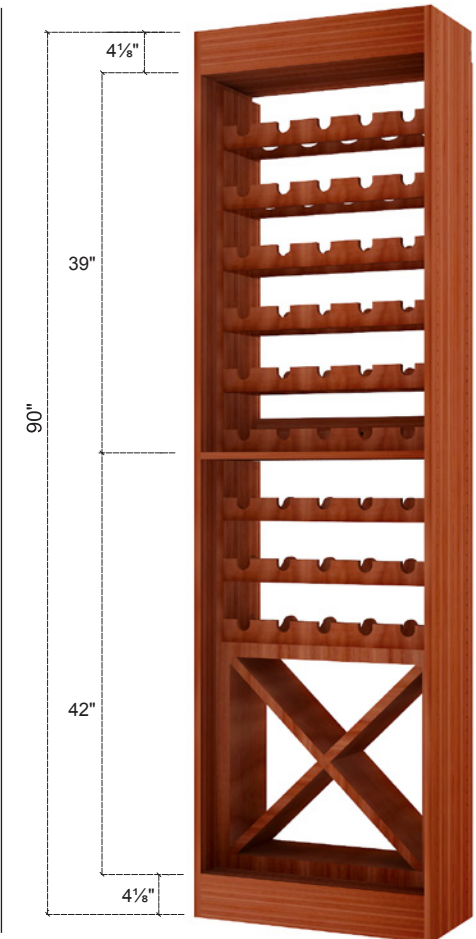

# MODEL: HGL-90" (4 OPTIONS) LONG HANG

HGL-90" (1) HGL-90" (2) HGL-90" (3) HGL-90" (4)

## INSTALLATION: PAGE 1 of 2

- 1 Install top of wall track, level, entire length of wall 89 ½ inches above the floor. Secure wall track to studs 16 inches on center with 2 inch screws. To splice wall track – overlap and install two 2 inch screws into sheet rock. (No stud required.)

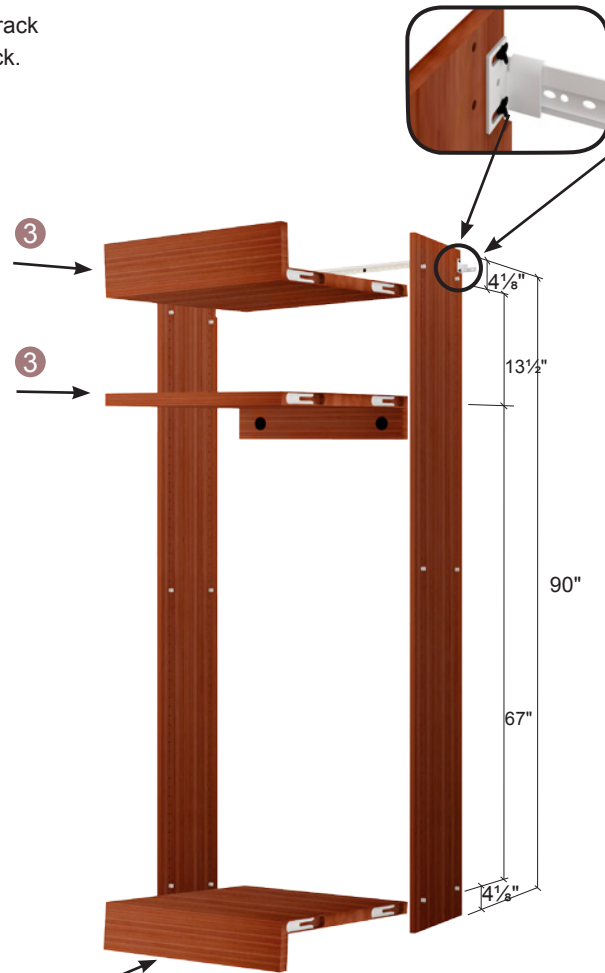
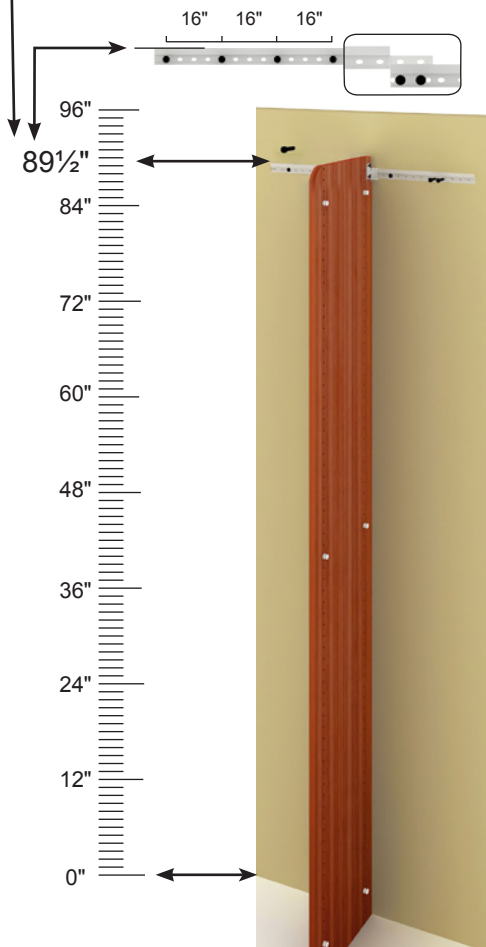

- 3 Slide the shelves onto fittings (installed in holes at designated height) starting from the bottom and working up.

- 2 Install mounting bracket to side/end panel with bolt and wing nut supplied. (Hand tight) Then hang panel to top of wall track.

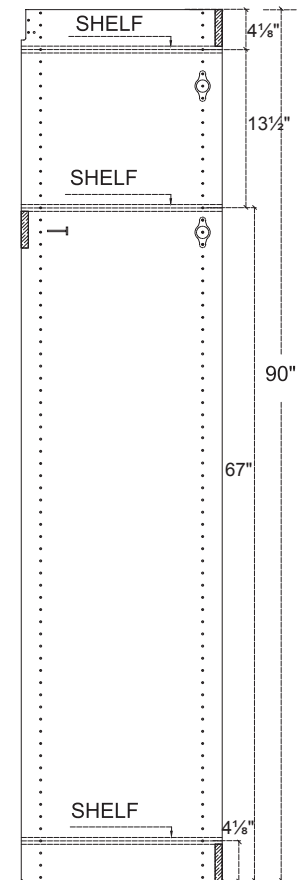
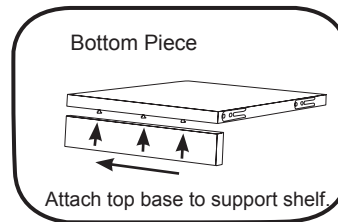
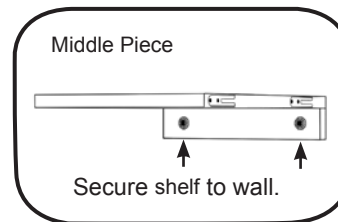
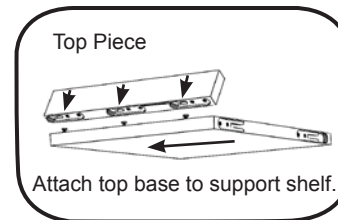

# MODEL: HGL-90" (1-4) LONG HANG

COLORS



Cherry Honey

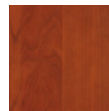

Cherry Medium

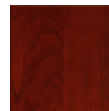

Cherry Dark

## INSTALLATION: PAGE 2 of 2

### HGL-90" (1)

Size inch			Amount	Colors
24"	30"	36"		

### HGL-90" (2)

Size inch			Amount	Colors
24"	30"	36"		

### HGL-90" (3)

Size inch			Amount	Colors
24"	30"	36"		

### HGL-90" (4)

Size inch			Amount	Colors
24"	30"	36"		

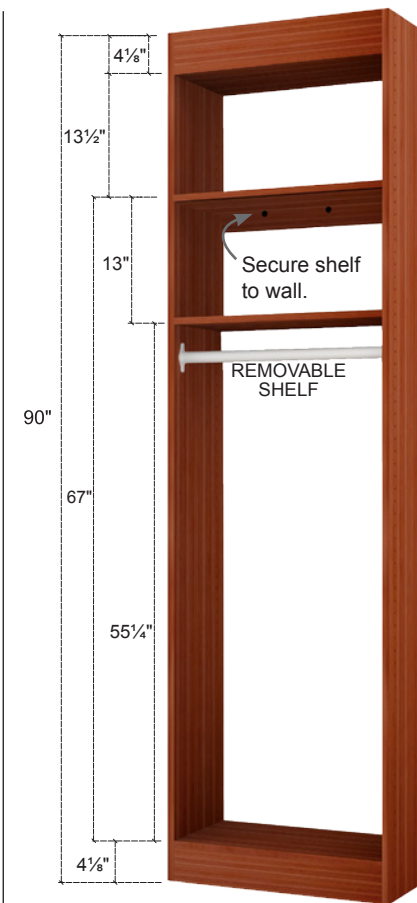
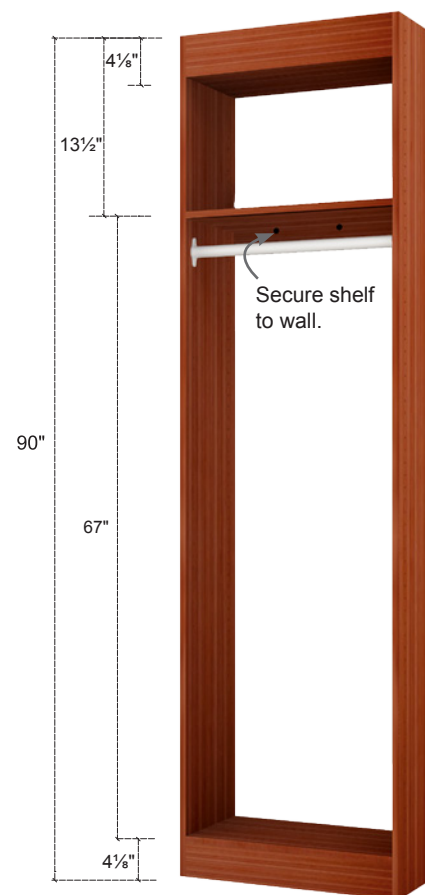
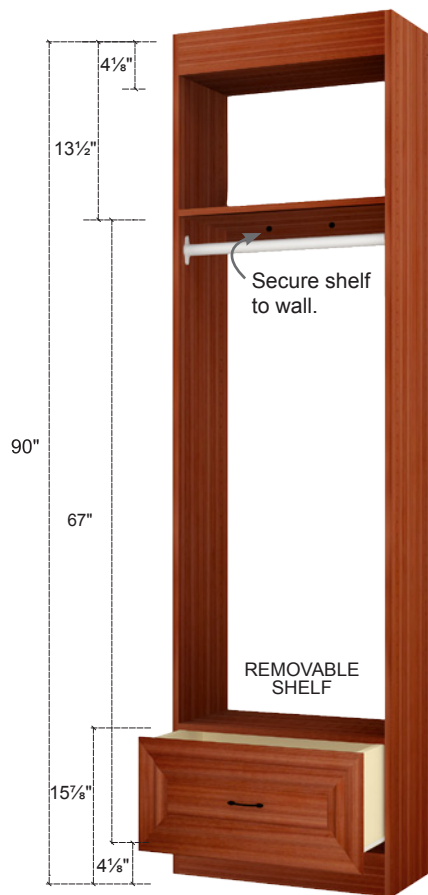
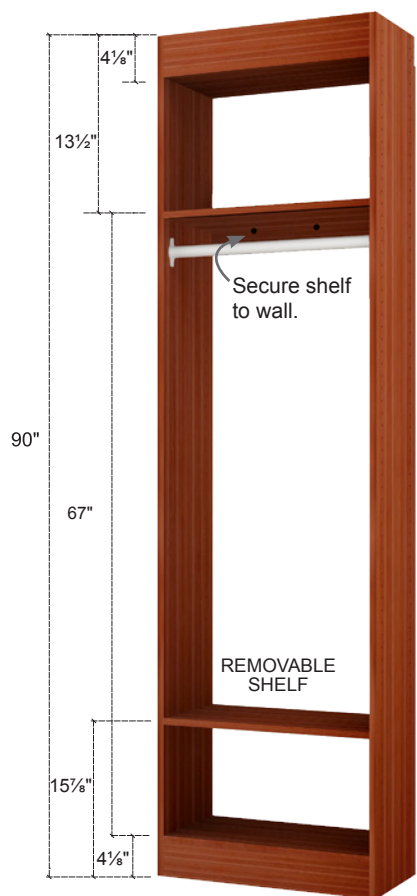

# MODEL: HP-90" (6 OPTIONS) HAMPER

HP-90" (1)

HP-90" (2)

HP-90" (3)

HP-90" (4)

HP-90" (5)

HP-90" (6)

## INSTALLATION: PAGE 1 of 3

**1** Install top of wall track, level, entire length of wall 89 1/2 inches above the floor. Secure wall track to studs 16 inches on center with 2 inch screws. To splice wall track – overlap and install two 2 inch screws into sheet rock. (No stud required.)

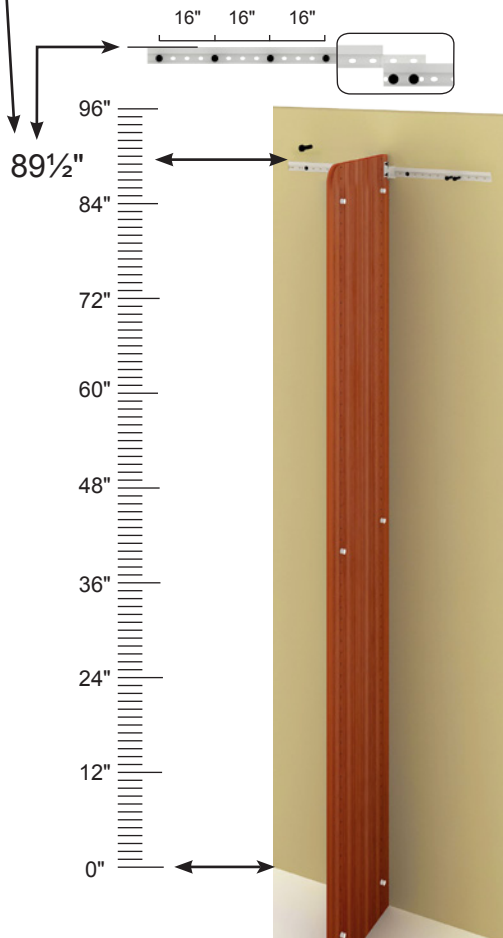

**2** Install mounting bracket to side/end panel with bolt and wing nut supplied. (Hand tight) Then hang panel to top of wall track.

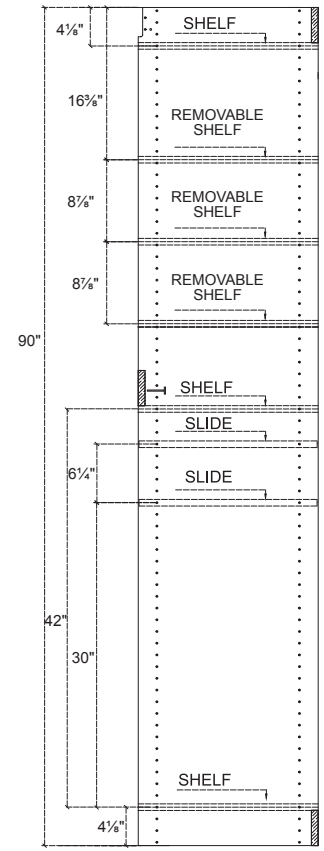
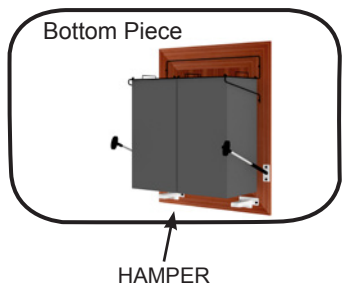
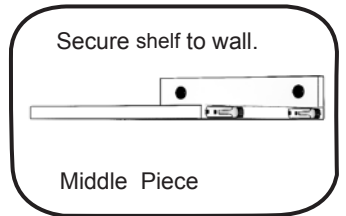
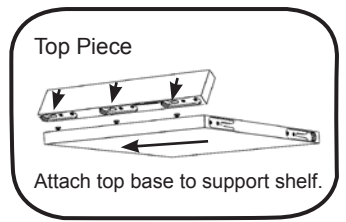
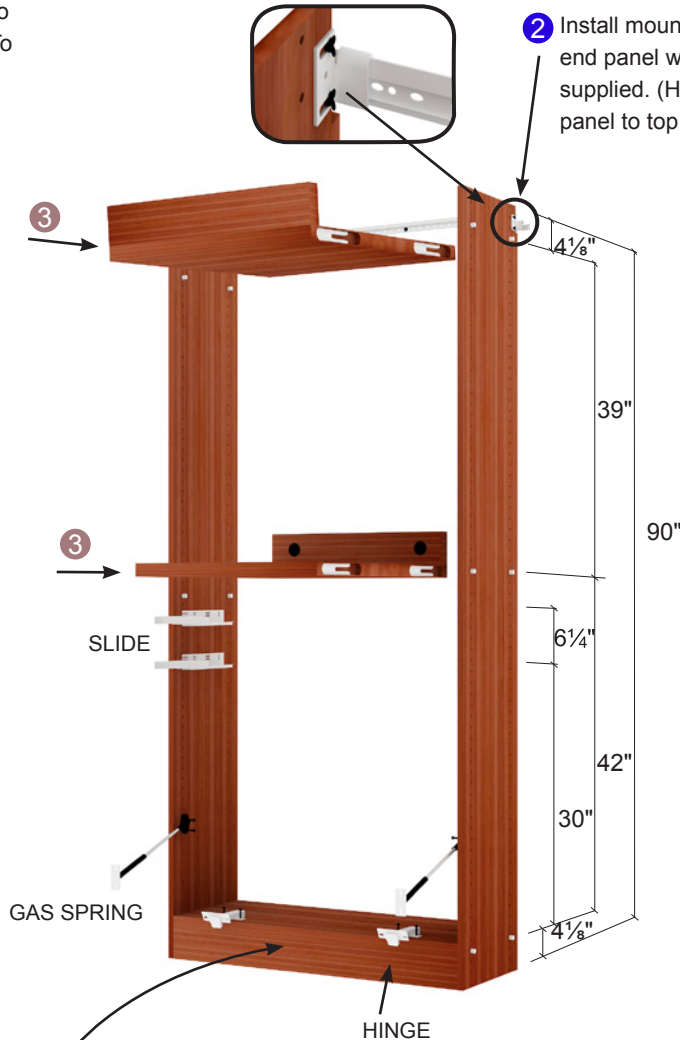

**3** Slide the shelves onto fittings (installed in holes at designated height) starting from the bottom and working up.



# MODEL: HP-90" (1-6) HAMPER

COLORS



Cherry Honey



Cherry Medium



Cherry Dark

## INSTALLATION: PAGE 2 of 3

### HP-90" (1)

Size inch			Amount	Colors
24"				



### HP-90" (2)

Size inch			Amount	Colors
24"				



### HP-90" (3)

Size inch			Amount	Colors
24"				



# MODEL: HP-90" (1-6) HAMPER

## COLORS



Cherry Honey

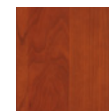

Cherry Medium

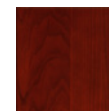

Cherry Dark

### INSTALLATION: PAGE 3 of 3

#### HP-90" (4)

Size inch			Amount	Colors
24"				



#### HP-90" (5)

Size inch			Amount	Colors
24"				



#### HP-90" (6)

Size inch			Amount	Colors
24"				



# STUDY BOOKCASES



Size inch				Amount	Colors
24"	30"				

## HGS90"

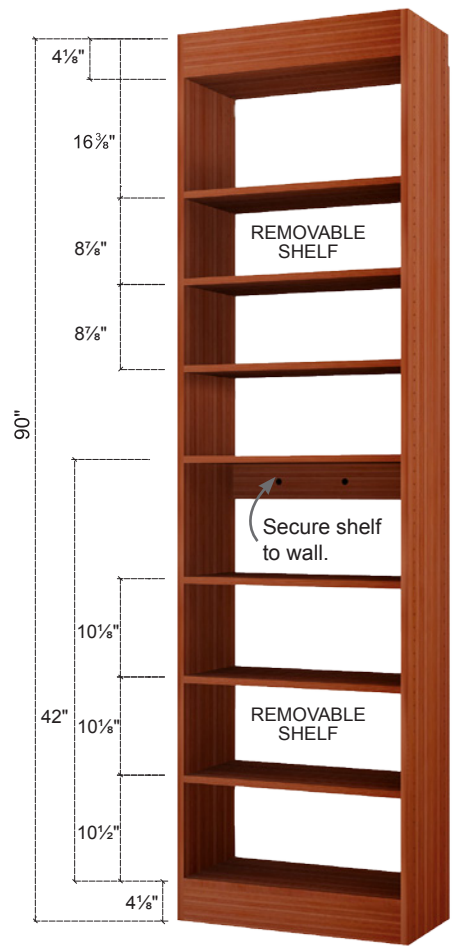

# MODEL: BS-90" (9 OPTIONS) BASKET

BS-90" (1) BS-90" (2) BS-90" (3) BS-90" (4)

BS-90" (5) BS-90" (6) BS-90" (7) BS-90" (8) BS-90" (9)

## INSTALLATION: PAGE 1 of 4

- 1** Install top of wall track, level, entire length of wall 89 1/2 inches above the floor. Secure wall track to studs 16 inches on center with 2 inch screws. To splice wall track – overlap and install two 2 inch screws into sheet rock. (No stud required.)

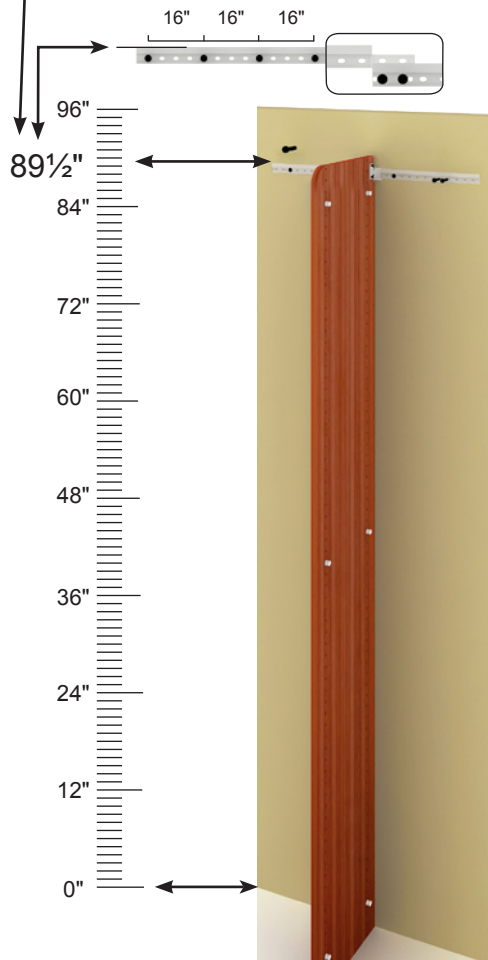

- 2** Install mounting bracket to side/end panel with bolt and wing nut supplied. (Hand tight) Then hang panel to top of wall track.

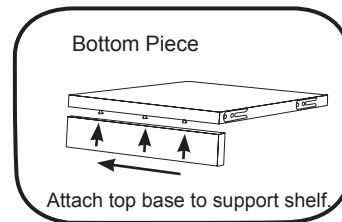
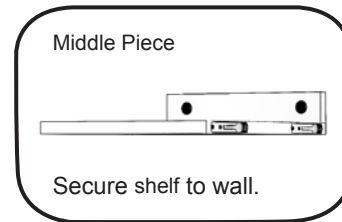
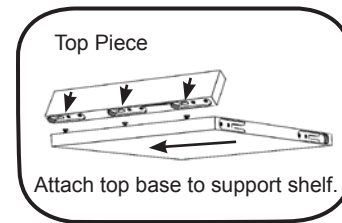
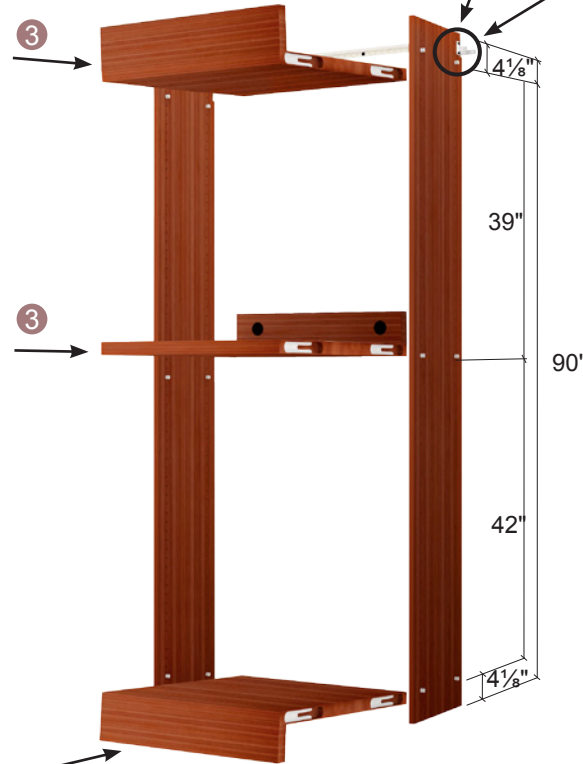

- 3** Slide the shelves onto fittings (installed in holes at designated height) starting from the bottom and working up.

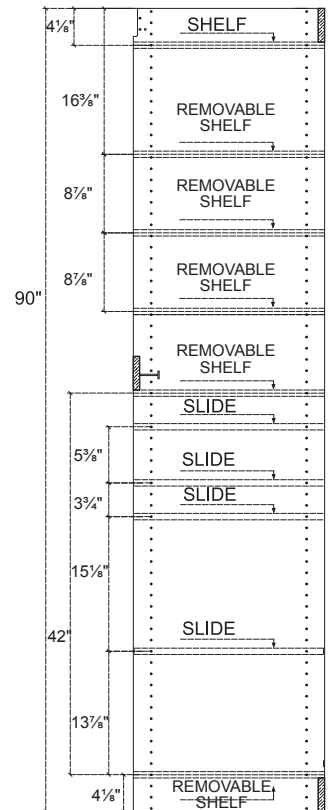

# MODEL: BS-90" (1-9) BASKET

## COLORS



Cherry Honey

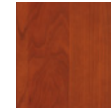

Cherry Medium



Cherry Dark

## INSTALLATION: PAGE 2 of 4

### BS-90" (1)

Size inch				Amount	Colors
24"					

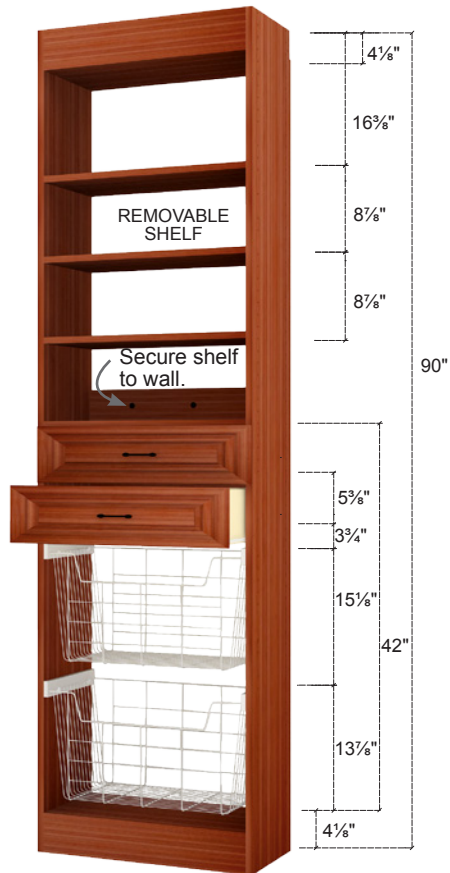

### BS-90" (2)

Size inch				Amount	Colors
24"					

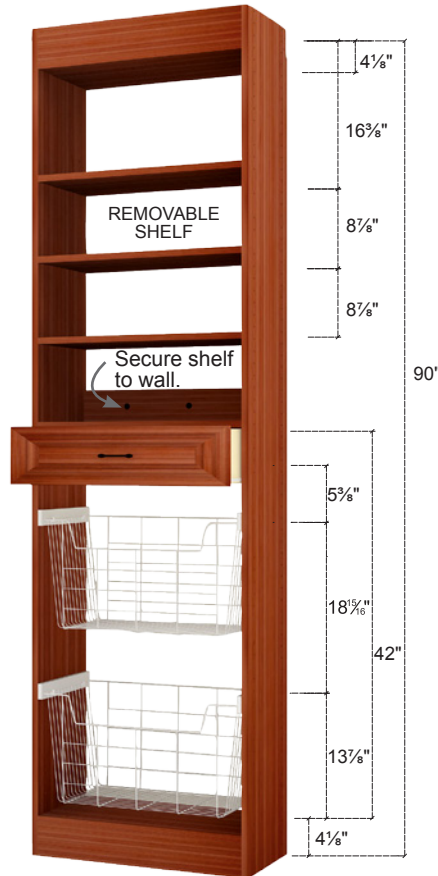

### BS-90" (3)

Size inch				Amount	Colors
24"					

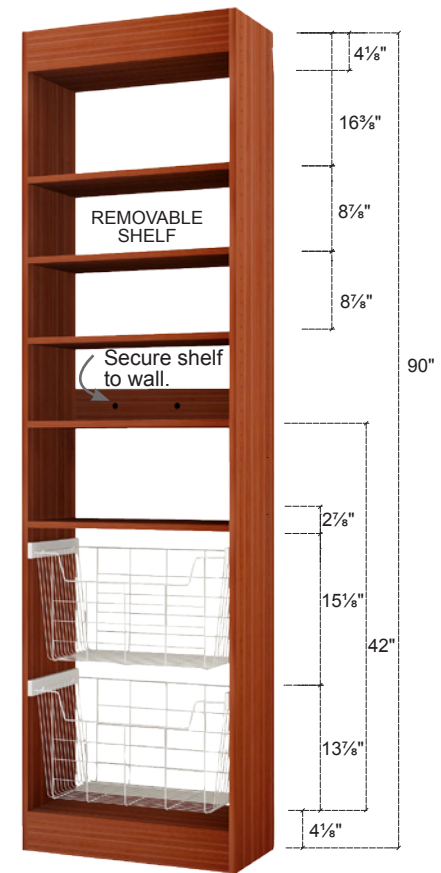

# MODEL: BS-90" (1-9) BASKET

## COLORS



Cherry Honey

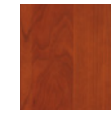

Cherry Medium



Cherry Dark

### INSTALLATION: PAGE 3 of 4

#### BS-90" (4)

Size	inch	Amount	Colors
24"			

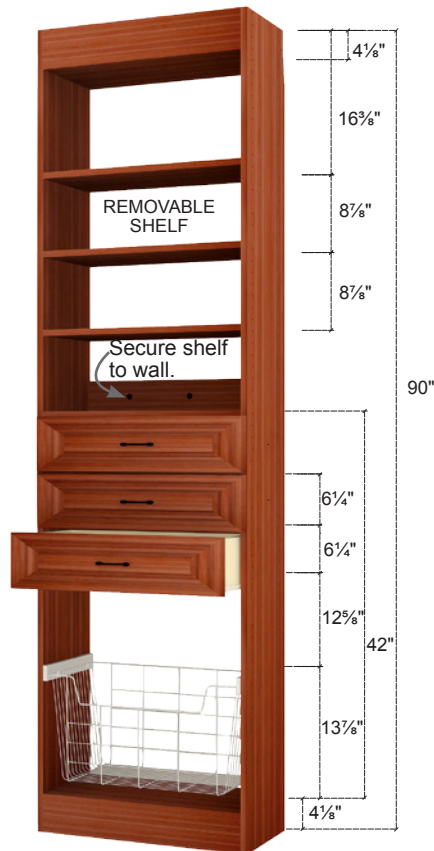

#### BS-90" (5)

Size	inch	Amount	Colors
24"			



#### BS-90" (6)

Size	inch	Amount	Colors
24"			

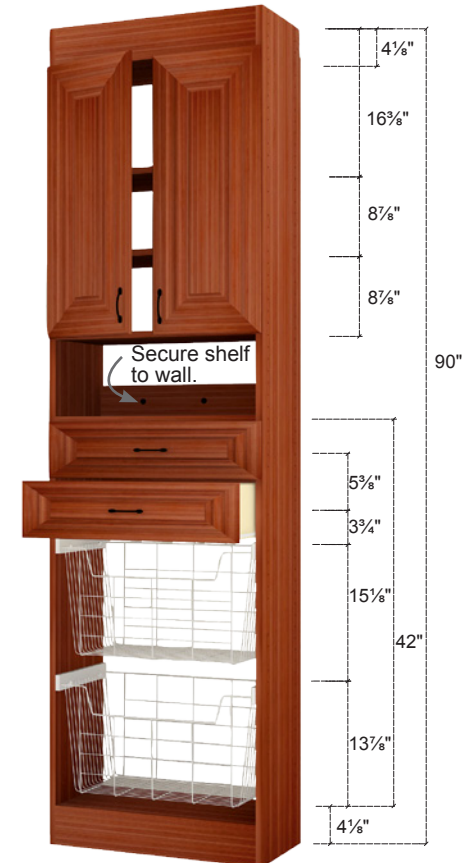

# MODEL: BS-90" (1-9) BASKET

COLORS



Cherry Honey

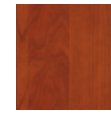

Cherry Medium



Cherry Dark

INSTALLATION: PAGE 4 of 4

## BS-90" (7)

Size inch			Amount	Colors
24"				



## BS-90" (8)

Size inch			Amount	Colors
24"				

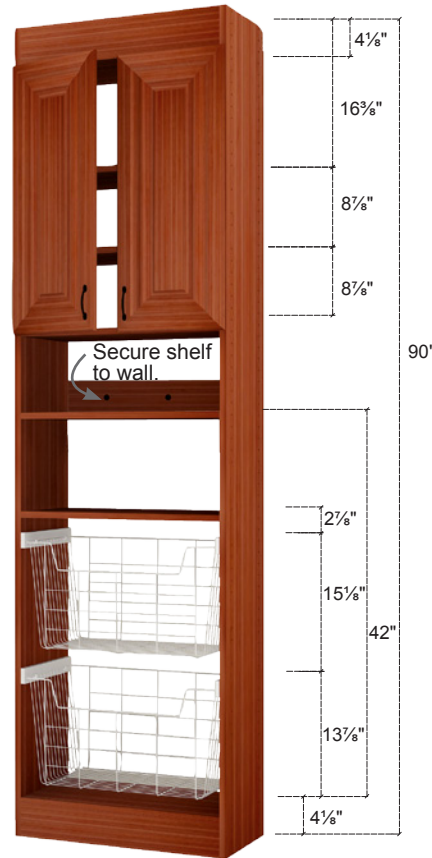

## BS-90" (9)

Size inch			Amount	Colors
24"				



# MODEL: DD-90" (12 OPTIONS) DRAWERS-DOOR

- DD-90" (1)
- DD-90" (2)
- DD-90" (3)
- DD-90" (4)
- DD-90" (5)
- DD-90" (6)
- DD-90" (7)
- DD-90" (8)
- DD-90" (9)
- DD-90" (10)
- DD-90" (11)
- DD-90" (12)

## INSTALLATION: PAGE 1 of 5

**1** Install top of wall track, level, entire length of wall 89 1/2 inches above the floor. Secure wall track to studs 16 inches on center with 2 inch screws. To splice wall track – overlap and install two 2 inch screws into sheet rock. (No stud required.)

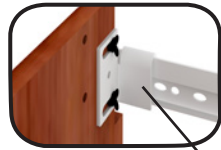
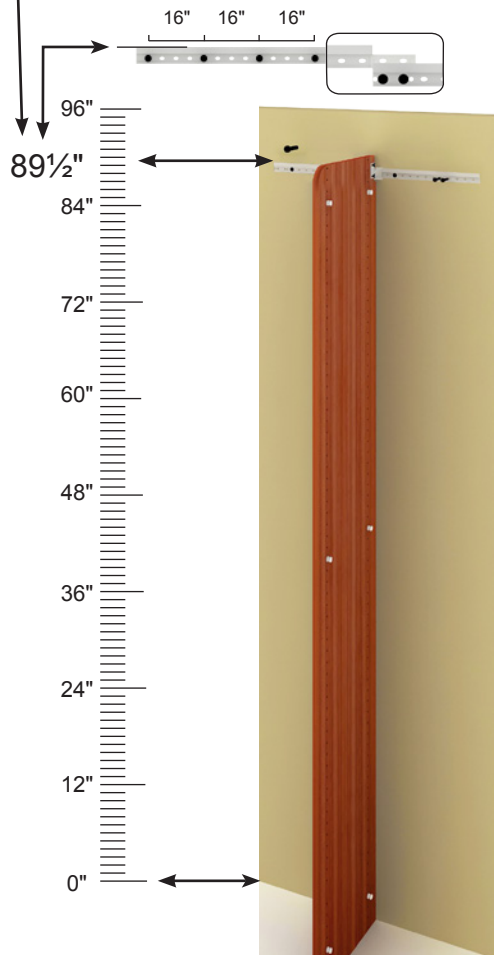

**2** Install mounting bracket to side/end panel with bolt and wing nut supplied. (Hand tight) Then hang panel to top of wall track.



**3** Slide the shelves onto fittings (installed in holes at designated height) starting from the bottom and working up.

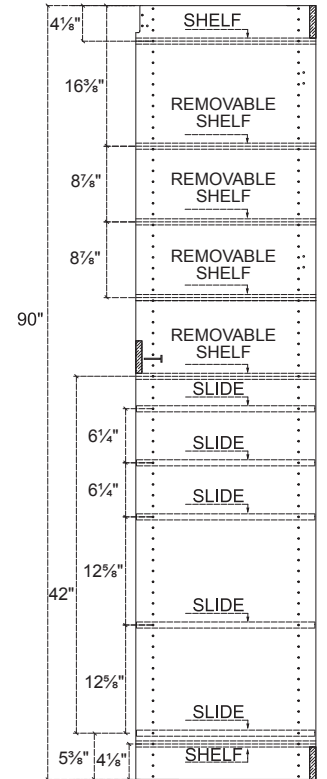
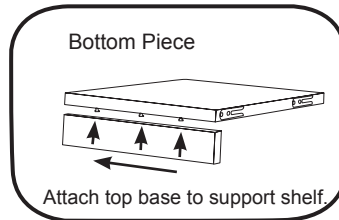
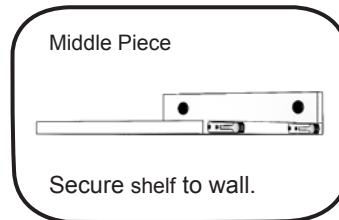
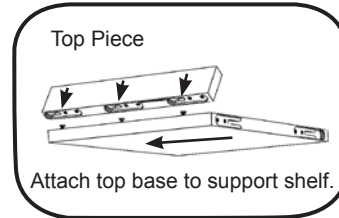



# MODEL: DD-90" (1-12) DRAWERS-DOOR

## COLORS



Cherry Honey

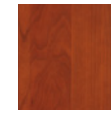

Cherry Medium



Cherry Dark

## INSTALLATION: PAGE 2 of 5

### DD-90" (1)

Size inch		Amount	Colors
24"	30"		



### DD-90" (2)

Size inch		Amount	Colors
24"	30"		

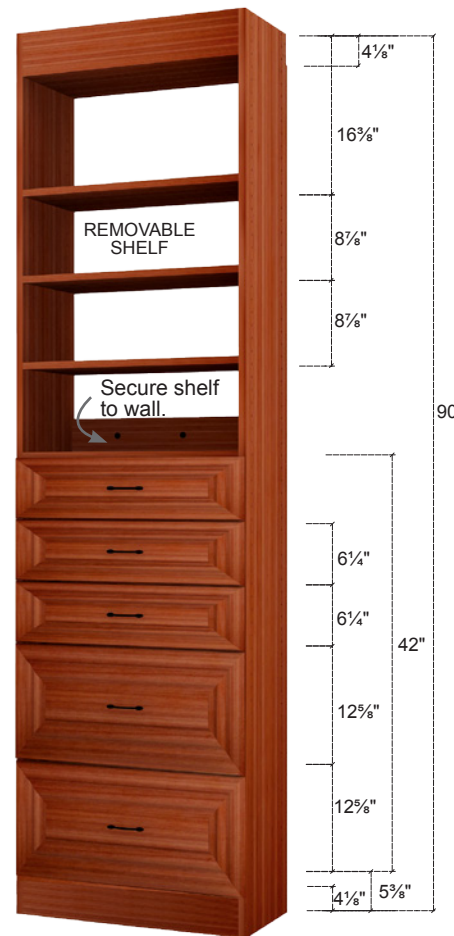

### DD-90" (3)

Size inch		Amount	Colors
24"	30"		



# MODEL: DD-90" (1-12) DRAWERS-DOOR

## COLORS



Cherry Honey

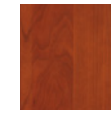

Cherry Medium



Cherry Dark

### INSTALLATION: PAGE 3 of 5

#### DD-90" (4)

Size inch		Amount	Colors
24"	30"		



#### DD-90" (5)

Size inch		Amount	Colors
24"	30"		



#### DD-90" (6)

Size inch		Amount	Colors
24"	30"		

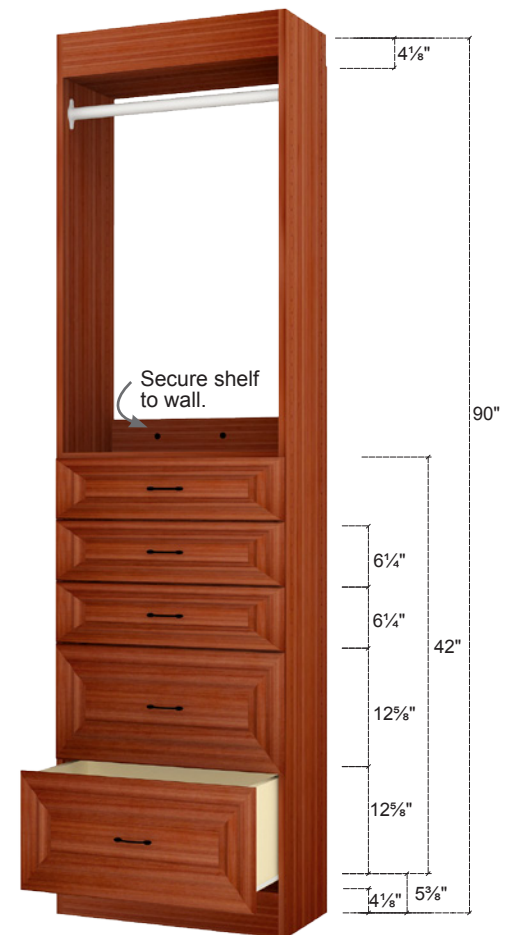

# MODEL: DD-90" (1-12) DRAWERS-DOOR

## COLORS



Cherry Honey

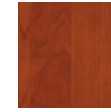

Cherry Medium



Cherry Dark

## INSTALLATION: PAGE 4 of 5

### DD-90" (7)

Size inch		Amount	Colors
24"	30"		



### DD-90" (8)

Size inch		Amount	Colors
24"	30"		

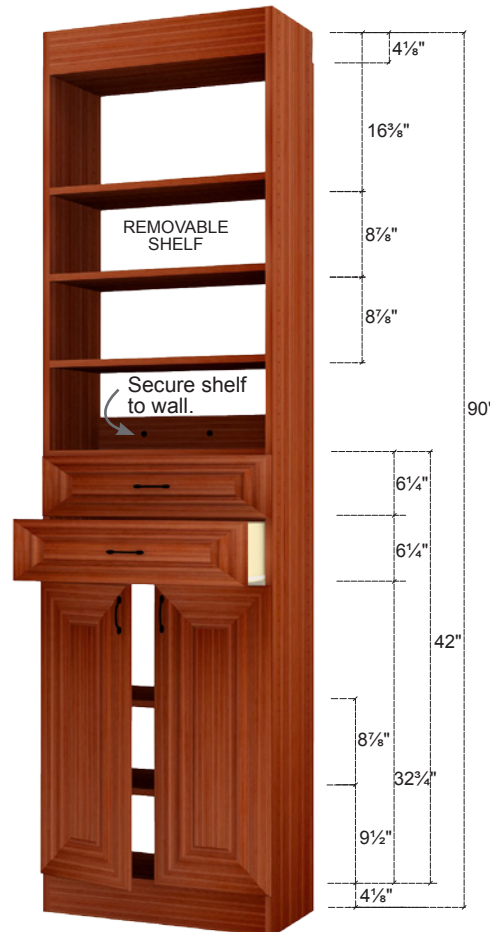

### DD-90" (9)

Size inch		Amount	Colors
24"	30"		

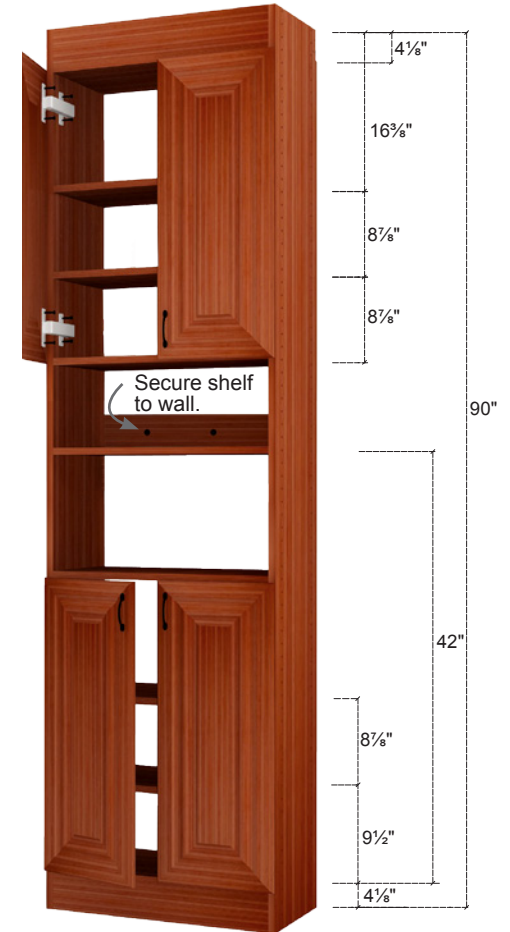

**MODEL: DD-90" (1-12)**  
**DRAWERS-DOOR**

**COLORS**



Cherry Honey

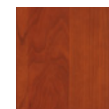

Cherry Medium

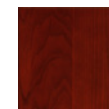

Cherry Dark

**INSTALLATION: PAGE 5 of 5**

**DD-90" (10)**

Size inch				Amount	Colors
24"	30"				

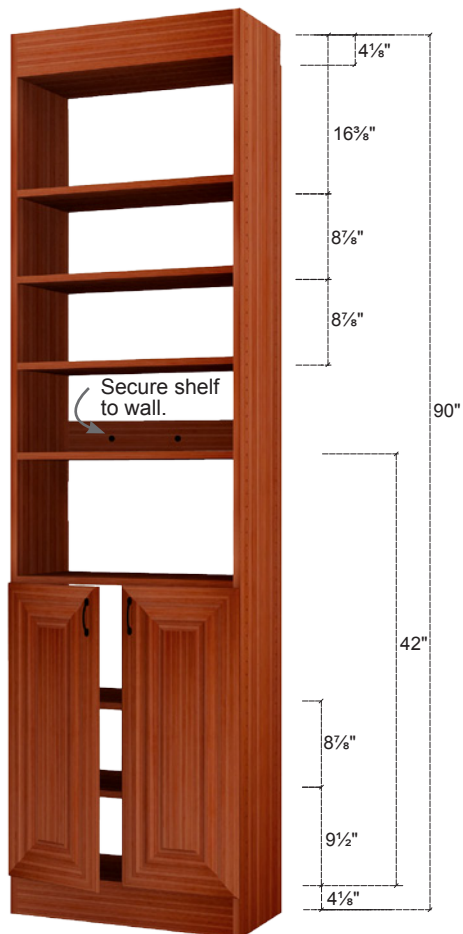

**DD-90" (11)**

Size inch				Amount	Colors
24"	30"				



**DD-90" (12)**

Size inch				Amount	Colors
24"	30"				



# WINE RACK



Size inch				Amount	Colors
24"					

## WINE RACK-2490

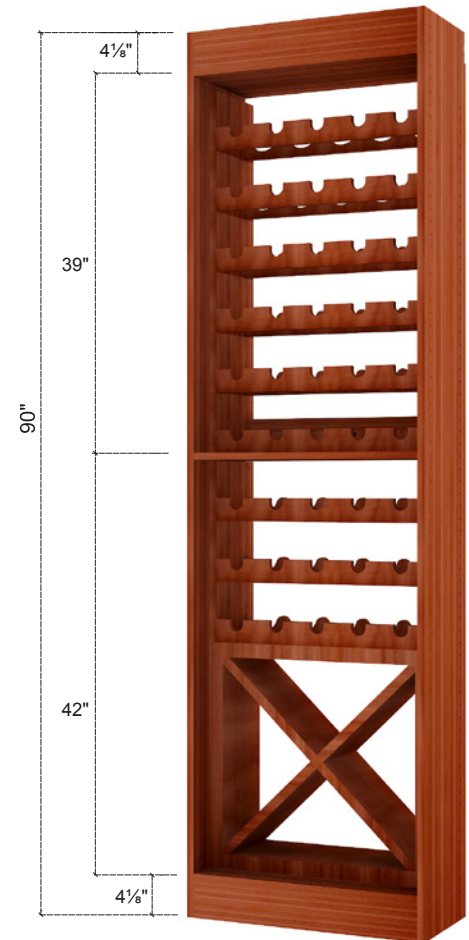

# MODEL: SH-90" ( 8 OPTIONS ) SHOE

- SH-90" (1)
- SH-90" (2)
- SH-90" (3)
- SH-90" (4)
- SH-90" (5)
- SH-90" (6)
- SH-90" (7)
- SH-90" (8)

## INSTALLATION: PAGE 1 of 4

**1** Install top of wall track, level, entire length of wall 89 1/2 inches above the floor. Secure wall track to studs 16 inches on center with 2 inch screws. To splice wall track – overlap and install two 2 inch screws into sheet rock. (No stud required.)

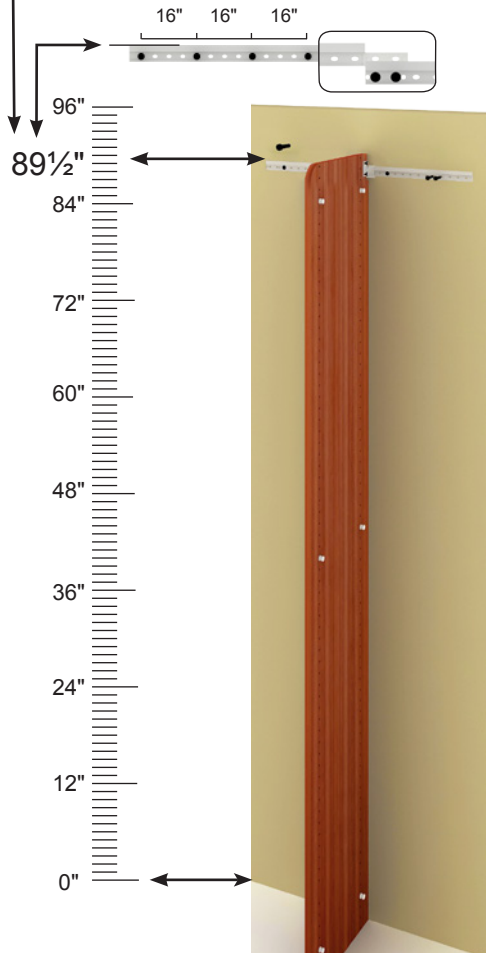

**2** Install mounting bracket to side/end panel with bolt and wing nut supplied. (Hand tight) Then hang panel to top of wall track.



**Top Piece**

Attach top base to support shelf.

**Middle Piece**

Secure shelf to wall.

**Bottom Piece**

Attach top base to support shelf.

**3** Slide the shelves onto fittings (installed in holes at designated height) starting from the bottom and working up.

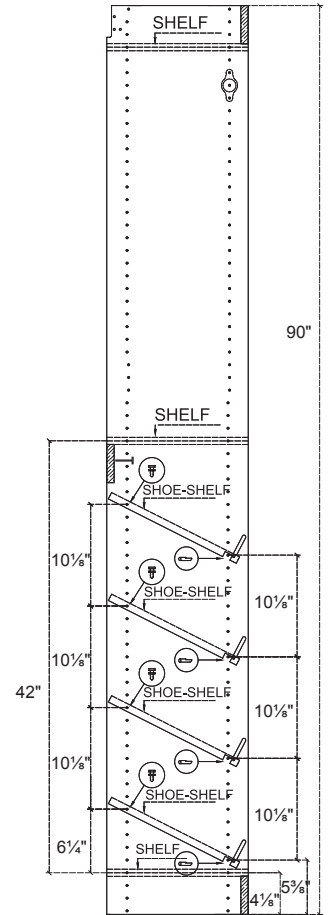

# MODEL: SH-90" (1-8) SHOE

## COLORS



Cherry Honey

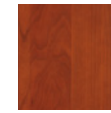

Cherry Medium



Cherry Dark

## INSTALLATION: PAGE 2 of 4

### SH-90" (1)

Size inch				Amount	Colors
24"	30"				



Slide clothes rod brackets onto clothes rod. Secure to side panel.

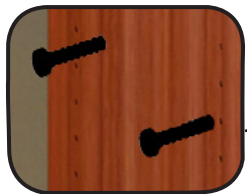

Secure shelf to wall.

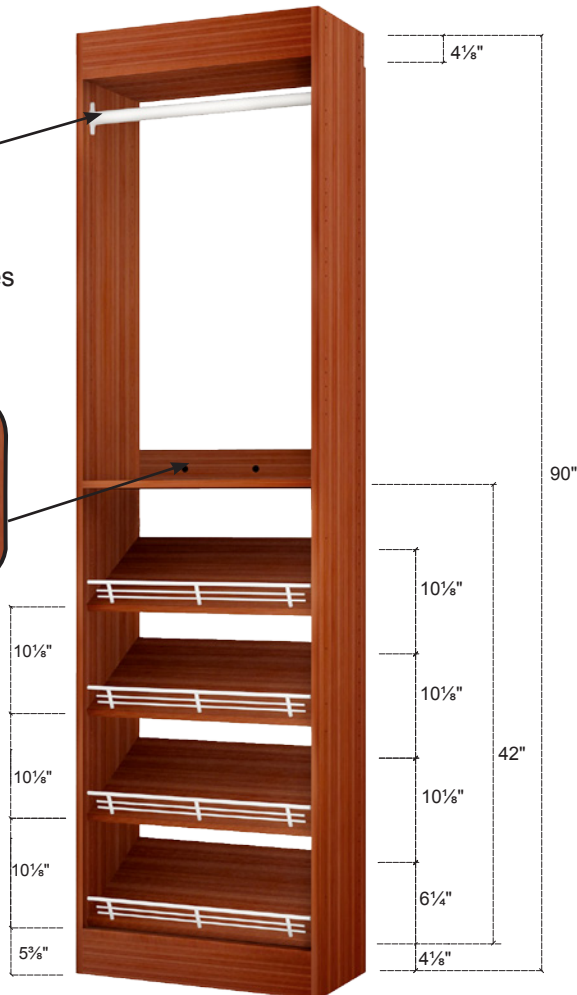

### SH-90" (2)

Size inch				Amount	Colors
24"	30"				



# MODEL: SH-90" (1-8) SHOE

## COLORS



Cherry Honey

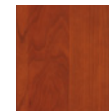

Cherry Medium



Cherry Dark

### INSTALLATION: PAGE 3 of 4

#### SH-90" (3)

Size inch		Amount	Colors
24"	30"		



#### SH-90" (4)

Size inch		Amount	Colors
24"	30"		

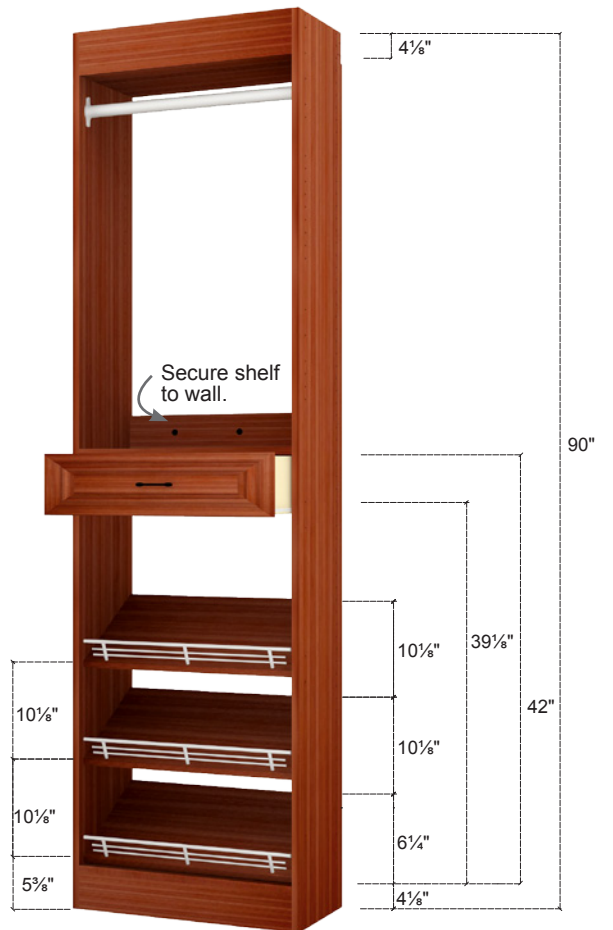

#### SH-90" (5)

Size inch		Amount	Colors
24"	30"		





# MODEL: SH-90" (1-8) SHOE

## COLORS



Cherry Honey

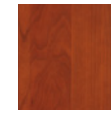

Cherry Medium



Cherry Dark

## INSTALLATION: PAGE 4 of 4

### SH-90" (6)

Size inch		Amount	Colors
24"	30"		

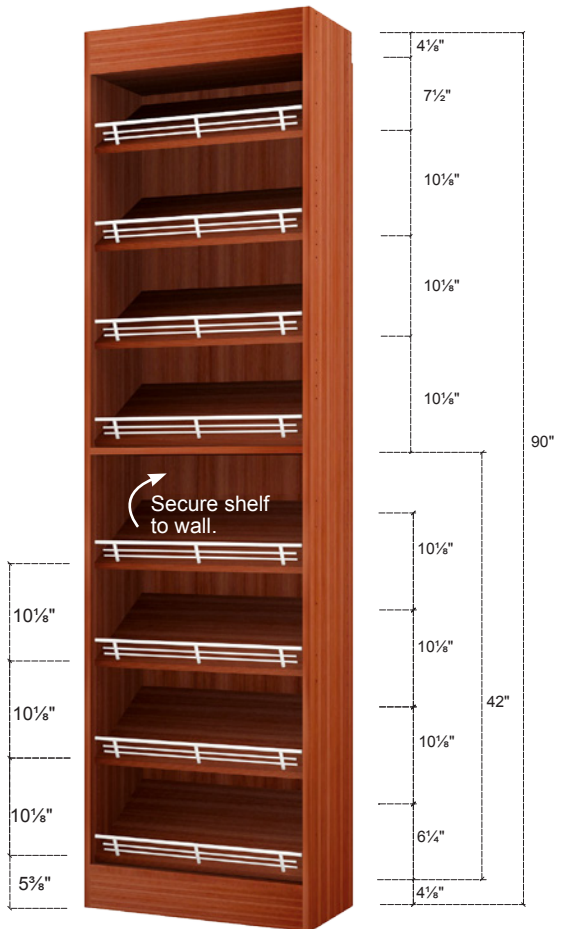

### SH-90" (7)

Size inch		Amount	Colors
24"	30"		



### SH-90" (8)

Size inch		Amount	Colors
24"	30"		



**INSTALLATION: PAGE 1 of 2**

- 1** Install top of wall track, level, entire length of wall 89 1/2 inches above the floor. Secure wall track to studs 16 inches on center with 2 inch screws. To splice wall track – overlap and install two 2 inch screws into sheet rock. (No stud required.)

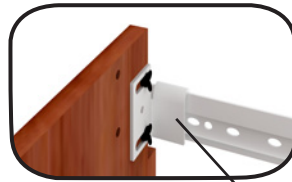
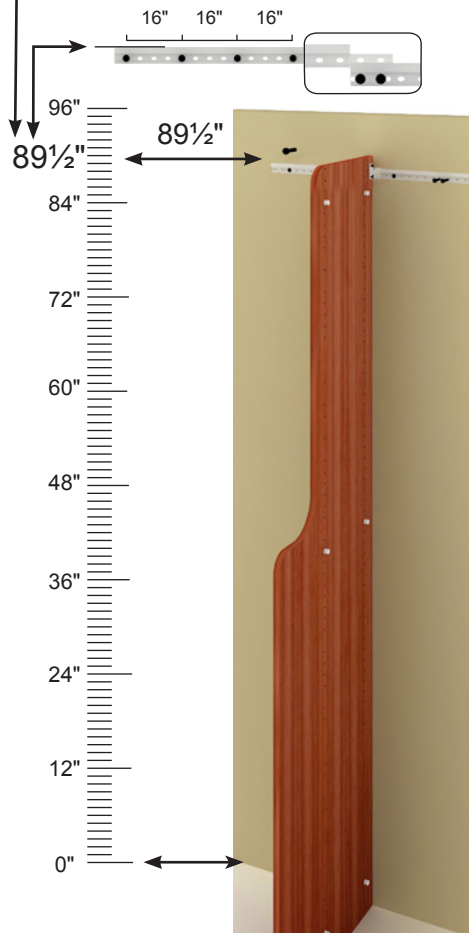

- 2** Install mounting bracket to side/end panel with bolt and wing nut supplied. (Hand tight) Then hang panel to top of wall track.

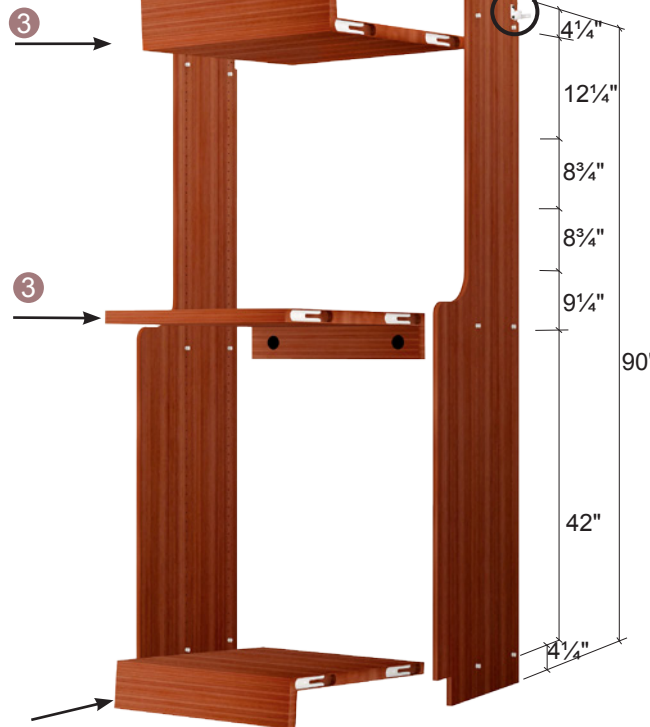

- 3** Slide the shelves onto fittings (installed in holes at designated height) starting from the bottom and working up.

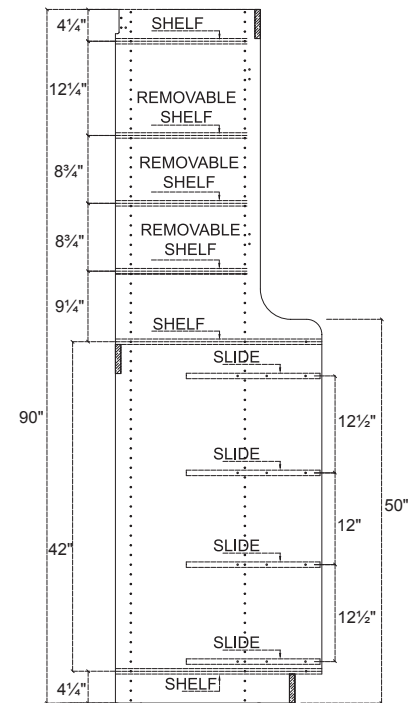
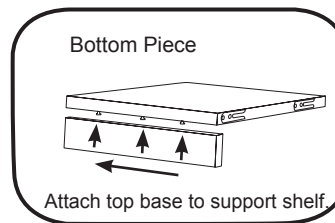
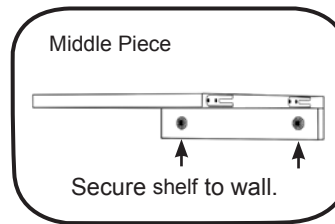
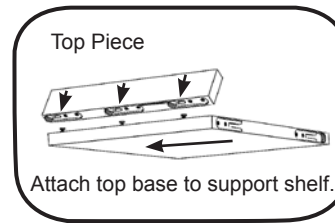

# MODEL: HU-3090 (1-2) HUTCHES

## COLORS



Cherry Honey

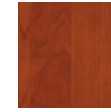

Cherry Medium



Cherry Dark

## INSTALLATION: PAGE 2 of 2

### HU-3090 (1)

Size inch				Amount	Colors
30"					

### HU-3090 (2)

Size inch				Amount	Colors
30"					



# MODEL: HD -71" (6 OPTIONS) T-HANG DRAWERS

HD-71" (1)

HD-71" (2)

HD-71" (3)

HD-71" (4)

HD-71" (5)

HD-71" (6)

## INSTALLATION: PAGE 1 of 3

**1** Install top of wall track, level, entire length of wall 86 inches above the floor. Secure wall track to studs 16 inches on center with 2 inch screws. To splice wall track – overlap and install two 2 inch screws into sheet rock. (No stud required.)

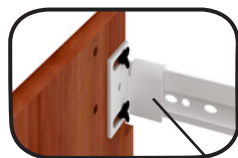
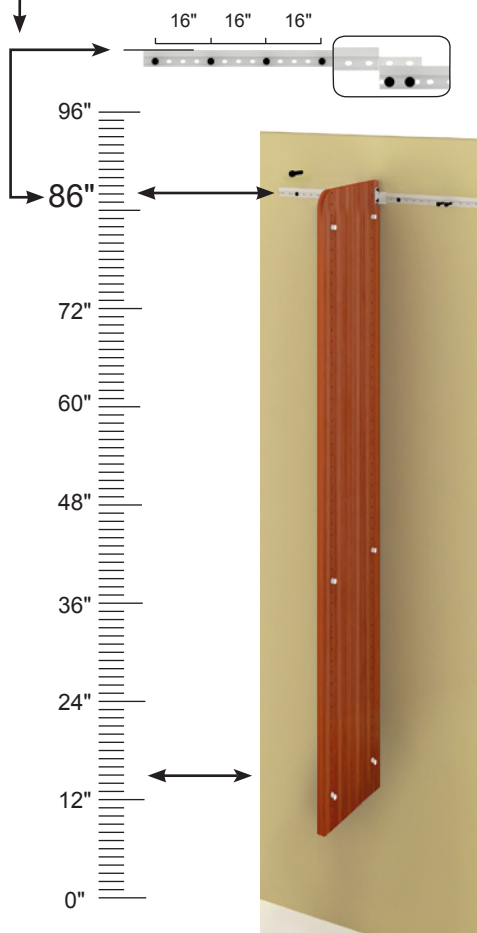

**2** Install mounting bracket to side/end panel with bolt and wing nut supplied. (Hand tight) Then hang panel to top of wall track.

**3**

**3**

**3**

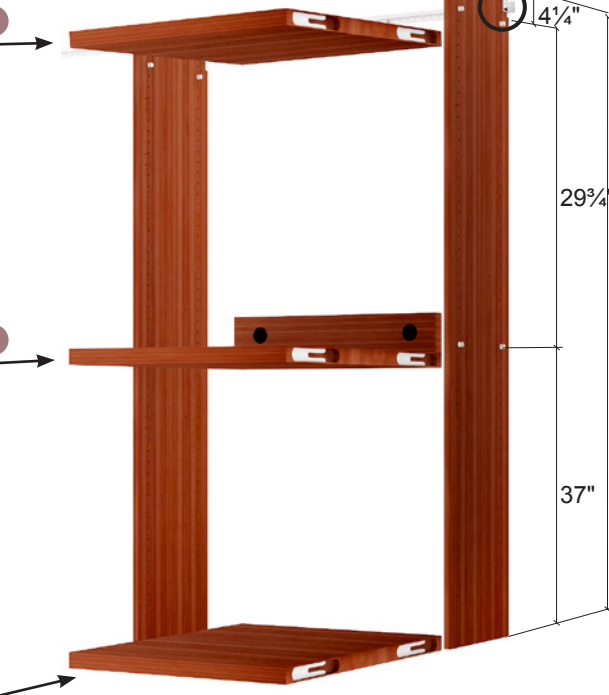

**Top Piece**

Attach top base to support shelf.

**Middle Piece**

Secure shelf to wall.

**Bottom Piece**

Attach top base to support shelf.

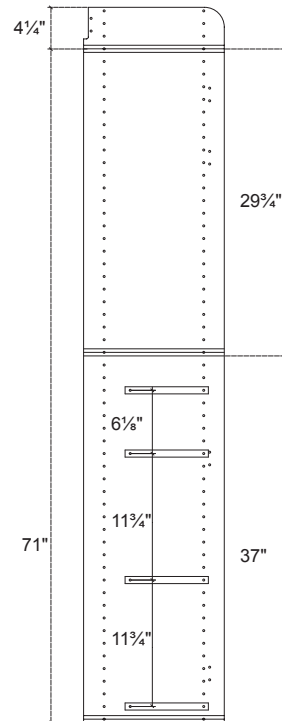

**3** Slide the shelves onto fittings (installed in holes at designated height) starting from the bottom and working up.

# MODEL: HD-71" (1-6) T-HANG DRAWERS

COLORS



Cherry Honey

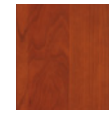

Cherry Medium



Cherry Dark

INSTALLATION: PAGE 2 of 3

## HD-71" (1)

Size inch			Amount	Colors
24"				



## HD-71" (2)

Size inch			Amount	Colors
24"				



## HD-71" (3)

Size inch			Amount	Colors
24"				

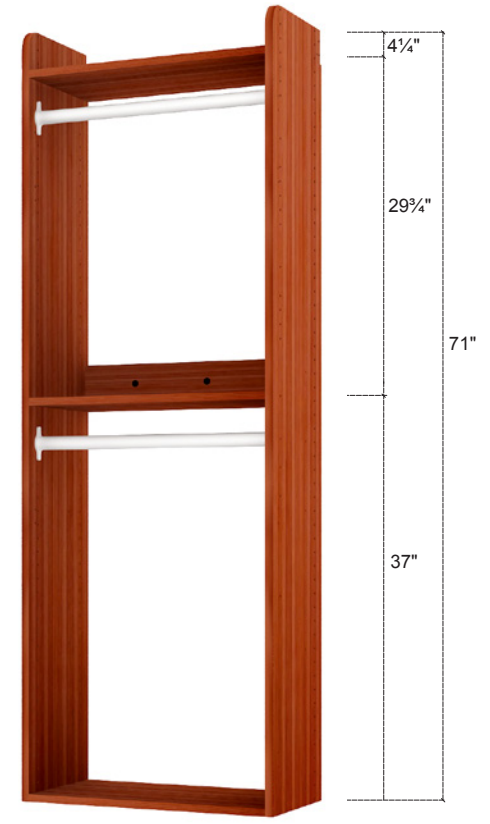

# MODEL: HD-71" (1-6) T-HANG DRAWERS

## COLORS



Cherry Honey

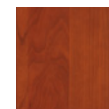

Cherry Medium



Cherry Dark

### INSTALLATION: PAGE 3 of 3

#### HD-71" (4)

Size	inch	Amount	Colors
24"			



#### HD-71" (5)

Size	inch	Amount	Colors
24"			



#### HD-71" (6)

Size	inch	Amount	Colors
24"			



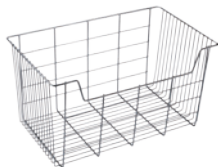

B-001  
Slide out basket

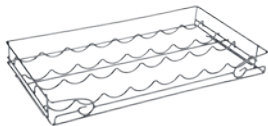

W-002  
Slide out wine rack

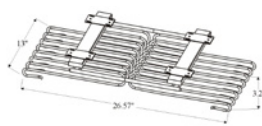

P-003  
Slide pants rack



S-004 (12")  
Soft-close smooth sliding



S-005 (20")  
Soft-close smooth sliding



G-006  
Gas spring



H-007  
Tilt-out hamper  
Removable bags



SCH-008  
SC Hinges



DH-009  
Door hinges



WSR-010  
Wire shoe rail



AP-011 (Black)  
Aluminum pole



PS-012 (Aluminum)  
Aluminum pole



WT-013  
Wall track



MB-014  
Mounting bracket



PB-015  
Patent bracket



PF-016  
Patent fitting



ASH-017  
Adj shelf holders



SH-018  
Shelf holders



Drawer & Door knobs

Slide-out belt rack

Slide-out tile rack

Slide-out valet rack

Jewelry trays



Light Baffle  
Moulding



Cabinet Soffit  
Moulding



Countertop Soffit  
Moulding



Combo Crown  
Moulding



Island Corner  
Moulding



Scribe Moulding



Base moulding

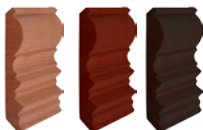

Crown moulding



**SC-303290 (1)**  
DOUBLE HANG (PAGE 02)



**SC-303290 (2)**  
DOUBLE HANG (PAGE 02)



**SC-303290 (3)**  
DOUBLE HANG (PAGE 02)



**SCL-303290 (1)**  
LONG HANG (PAGE 04)



**SCL-303290 (2)**  
LONG HANG (PAGE 04)



**SCL-303290 (3)**  
LONG HANG (PAGE 04)



**SC-303247 (1)**  
DOUBLE HANG (PAGE 06)



**SC-303247 (2)**  
DOUBLE HANG (PAGE 06)



**SCL-303247 (1)**  
LONG HANG (PAGE 08)



**SCL-303247 (2)**  
LONG HANG (PAGE 08)



**HG-47" (1)**  
DOUBLE HANG (PAGE 10)



**HG-47" (2)**  
DOUBLE HANG (PAGE 10)



**HGL-47" (1)**  
LONG HANG (PAGE 12)



**HGL-47" (2)**  
LONG HANG (PAGE 12)



**HG-90" (1)**  
DOUBLE HANG (PAGE 14)



**HG-90" (2)**  
DOUBLE HANG (PAGE 14)



**HG-90" (3)**  
DOUBLE HANG (PAGE 14)



**HGS-90" (4)**  
DOUBLE HANG (PAGE 14)





**GC309018 (1)**  
DOUBLE DOOR (PAGE 16)



**GC309018 (2)**  
DOUBLE DOOR (PAGE 16)



**GS309018 (3)**  
DOUBLE DOOR (PAGE 16)



**WINE RACK-2490 (4)**  
DOUBLE DOOR (PAGE 16)



**HGL-90" (1)**  
LONG HANG (PAGE 18)



**HGL-90" (2)**  
LONG HANG (PAGE 18)



**HGL-90" (3)**  
LONG HANG (PAGE 18)



**HGL-90" (4)**  
LONG HANG (PAGE 18)



**HP-90" (1)**  
HAMPER (PAGE 20)



**HP-90" (2)**  
HAMPER (PAGE 20)



**HP-90" (3)**  
HAMPER (PAGE 20)



**HP-90" (4)**  
HAMPER (PAGE 21)



**HP-90" (5)**  
HAMPER (PAGE 21)



**HP-90" (6)**  
HAMPER (PAGE 21)



**BS-90" (1)**  
BASKET (PAGE 24)



**BS-90" (2)**  
BASKET (PAGE 24)



**BS-90" (3)**  
BASKET (PAGE 24)



**BS-90" (4)**  
BASKET (PAGE 25)



**BS-90" (5)**  
BASKET (PAGE 25)



**BS-90" (6)**  
BASKET (PAGE 25)



**BS-90" (7)**  
BASKET (PAGE 26)



**BS-90" (8)**  
BASKET (PAGE 26)



**BS-90" (9)**  
BASKET (PAGE 26)



**DD-90" (1)**  
DRAWERS-DOOR (PAGE 28)



**DD-90" (2)**  
DRAWERS-DOOR (PAGE 28)



**DD-90" (3)**  
DRAWERS-DOOR (PAGE 28)



**DD-90" (4)**  
DRAWERS-DOOR (PAGE 29)



**DD-90" (5)**  
DRAWERS-DOOR (PAGE 29)



**DD-90" (6)**  
DRAWERS-DOOR (PAGE 29)



**DD-90" (7)**  
DRAWERS-DOOR (PAGE 30)



**DD-90" (8)**  
DRAWERS-DOOR (PAGE 30)



**DD-90" (9)**  
DRAWERS-DOOR (PAGE 30)



**DD-90" (10)**  
DRAWERS-DOOR (PAGE 31)



**DD-90" (11)**  
DRAWERS-DOOR (PAGE 31)



**DD-90" (12)**  
DRAWERS-DOOR (PAGE 31)



**SH-90" (1)**  
SHOE (PAGE 34)



SH-90" (2)  
SHOE (PAGE 34)



SH-90" (3)  
SHOE (PAGE 35)



SH-90" (4)  
SHOE (PAGE 35)



SH-90" (5)  
SHOE (PAGE 35)



SH-90" (6)  
SHOE (PAGE 36)



SH-90" (7)  
SHOE (PAGE 36)



SH-90" (8)  
SHOE (PAGE 36)



HU-3090 (1)  
HUTCHES (PAGE 38)



HU-3090 (2)  
HUTCHES (PAGE 38)



D-71" (1)  
T-HANG DRAWERS (PAGE 40)



D-71" (2)  
T-HANG DRAWERS (PAGE 40)



D-71" (3)  
T-HANG DRAWERS (PAGE 40)



D-71" (4)  
T-HANG DRAWERS (PAGE 41)



D-71" (5)  
T-HANG DRAWERS (PAGE 41)



D-71" (6)  
T-HANG DRAWERS (PAGE 41)

# BASE CABINETS

## COLORS



Cherry Honey



Cherry Medium



Cherry Dark



- B09 (L/R)
- B12 (L/R)
- B15 (L/R)
- B18 (L/R)



- B21
- B24
- B27
- B30
- B33
- B36



- BS24
- BS30
- BS36



- B12-D3
- B15-D3
- B18-D3
- B21-D3



- B24-D3
- B30-D3



- B24-D4



- BCT36



- BSO30



- BSA36 (L/R)

# BASE CABINETS

## COLORS



Cherry Honey

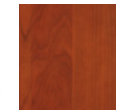

Cherry Medium



Cherry Dark



BSC36 (L/R)



TP1885 1/2(L/R)   
 TP1891(L/R)   
 TP1895(L/R)



TP2485 1/2   
 TP2491   
 TP2495



TALL SINGLE-MIC-  
 OVEN-D3  
 TSMO309126



TALL DOUBLE-  
 OVEN-D1  
 TDO309126



TALL SINGLE-MIC-  
 OVEN-D3  
 TSMO309526



TALL DOUBLE-  
 OVEN-D1  
 TDO309526

# VANITY BASE CABINETS

## COLORS



Cherry Honey

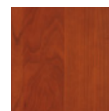

Cherry Medium



Cherry Dark



VD3-1232-22

VD3-1532-22

VD3-1832-22



VD3-1235-22

VD3-1535-22

VD3-1835-22



VS2432-22



VSD2-3632-22-DOOR-R



VSD2-3632-22-DOOR-L



VS-2435-22

# WALL CABINETS

## COLORS

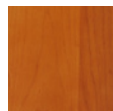

Cherry Honey

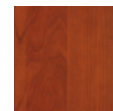

Cherry Medium



Cherry Dark



- W0930 (L/R)
- W1230 (L/R)
- W1530 (L/R)
- W1830 (L/R)



- W0936 (L/R)
- W1236 (L/R)
- W1536 (L/R)
- W1836 (L/R)



- W0940 (L/R)
- W1240 (L/R)
- W1540 (L/R)
- W1840 (L/R)



- W2130
- W2430
- W2730
- W3030
- W3330
- W3630



- W2136
- W2436
- W2736
- W3036
- W3336
- W3636



- W2140
- W2440
- W2740
- W3040
- W3340
- W3640

# WALL CABINETS

## COLORS



Cherry Honey

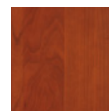

Cherry Medium



Cherry Dark



- WA 2430
- WA 2436
- WA2440



- WSC 2430
- WSC 2436
- WSC 2440



- WMIC303021
- WMIC303621
- WMIC304021



- CCM3058 1/2 21



# WALL CABINETS

## COLORS



Cherry Honey

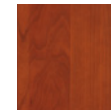

Cherry Medium



Cherry Dark



W2412   
 W3012   
 W3612   
 W361224



W2415   
 W3015   
 W3615



W2418   
 W3018   
 W3618   
 W361824



W2421   
 W3021   
 W3621



W2424   
 W3024   
 W3624



W1858 1/2 12-D3

## SET CABINETS

## COLORS



Cherry Honey

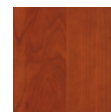

Cherry Medium

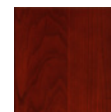

Cherry Dark

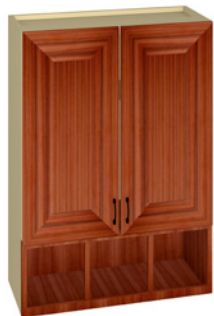
WG1230 1/2(L/R) WG1236 (L/R) WG1240 (L/R) WG2430 1/2 WG2436 WG2440 WG3030 1/2 WG3036 WG3040 DLO 3040 DLO 3640 WG3018 WG3618 B9FHPOS B19DWB

# SET CABINETS

## COLORS



Cherry Honey

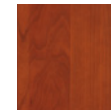

Cherry Medium



Cherry Dark



WR3018



LOS 30 8 1/2

LOS 36 8 1/2



SGH3011



WFB 1858 1/2

WFB 2458 1/2

WFB 1854 1/2

WFB 2454 1/2



WOES930 1/2 L/R

WOES936 L/R

WOES940 L/R



BOES9 L/R



DD30

DD36

# KITCHEN PANTRY



# WALK-IN CLOSET



# REACH - IN CLOSET



## CUSTOM CLOSETS & KITCHEN CABINETS:

Creating a beautifully organized space, whether it is your closet, kitchen cabinets, pantry, study room, laundry room, or garage storage – it is easy with the help of Johnson Closets & Cabinets. We are committed to deliver a customized solution with unparalleled level of quality, design, service at a cost that fits your budget and vision.

# GARAGE STORAGE









JOHNSON CLOSETS



JOHNSONCLOSETS.COM

## FREE DESIGN SERVICE

Let us Design For You

We are always here to help! Our professional design team can offer design support to provide you with a design that is functional, aesthetically pleasing, and uses your space effectively.

Schedule A Design Consultation Appointment

We are pleased to offer complimentary in-home consultation for a custom design solution.

Request A Free Design By Fax or Email

If you have an overhead drawing of your space with all the necessary measurements, you can fax (206-275-4566) or email it to our design center (support@johnsonclosets.com).

We will create a design for you within two business days.

Tel: (206) 275-4567 Fax: (206) 275-4566  
 support@johnsonclosets.com www.johnsonclosets.com  
 P.O. Box 317, Mercer Island, WA 98040





[www.johnsonclosets.com](http://www.johnsonclosets.com)

Tel: (206) 275-4567 Fax: (206) 275-4566  
support@johnsonclosets.com  
P.O. Box 317 Mercer Island, WA 98040